

ETNC24-FC-BAC-PIR-02

Owner's manual & Technician Settings



Index

Operating instructions	4-6
Turning the thermostat ON and OFF	
Selecting temperature scale	
Adjusting the Set point temperature (for 1 set point and 2 set points configurations)	
Selecting system mode	
Selecting Fan speeds (for 2 and 3 fan speeds configuration)	
Turning Auto fan ON or OFF (fan on demand)	
Locking the thermostat buttons	
Resetting filter alarm	
Sleep mode	
Economy mode	
Freeze Protection	
Installation	7
Wiring	8
Jumpers	9
End of line resistor	
Temperature display – Set point & Ambient or Set point only	
Enable / Disable PIR detector	
No valve configuration	
Chilled beam configuration	
Floor heating configuration	
DIP Switch settings	10-12
Number of fan speeds	
2-Pipe / 4-Pipe system	
Enable/Disable Electric heater on 2nd stage heating	
Communication MAC Address / MAC Address table	

Index

Technician settings.....	13-26
P01 – Offset for temperature readings calibration	P29 – LCD Backlight ON or OFF
P02 – Set point limit for cooling	P30 – Beeper ON or OFF
P03 – Set point limit for heating	P31 – Fan ON delay in cooling (seconds)
P04 – Lock the [Fan] button	P32 – Fan OFF delay in cooling (seconds)
P05 – Lock the [Mode] button	P33 – Fan ON delay in heating (seconds)
P06 – Lock the [On/Off] button	P34 – Fan OFF delay in heating (seconds)
P07 – Lock the [+] and [-] buttons (Set buttons)	P35 – Enable/Disable Freeze protection
P08 – Functionality of T1 terminals	P36 – Freeze protection cut-in set point
P09 – Functionality of In1,0 terminals	P37 – Freeze protection cut-out set point
P10 – Window contact (terminals In1,0) polarity	P40 – View filter counter (hours) – Read only
P11 – Window contact delay time	P41 – Reset filter time
P12 – Door switch (terminals T1,0) polarity	P42 – Adjust filter alarm delay counter (hours)
P13 – Door switch delay time	P43 – Soft start in heat – cut-in temperature
	P44 – Soft start in heat – cut-out temperature
P14 – Enable/Disable Auto change over mode	P45 – Cool differential band
P15 – Occupancy sensor logic (PIR)	P46 – Cool differential band offset
P16 – Enable/Disable Occupancy sensor	P47 – Heat differential band
P17 – PIR (occupancy sensor) delay time	P48 – Heat differential band offset
P18 – PIR (Occupancy sensor) polarity	P49 – Shift between Cool and Heat in Auto mode
P22 – Sleep mode time delay	P51 – Shift between Heating stages
P23 – Sleep mode offset in cooling	P83 – View T2 temperature sensor readings
P24 – Sleep mode offset in heating	P84 – View T3 temperature sensor readings
P25 – Economy set point for cooling	P99 – One or Two set points
P26 – Economy set point for heating	
RT03 Remote control - option.....	27

Operating instructions

Turning the thermostat ON and OFF

- Press the [On/Off] button to turn the thermostat ON or OFF.

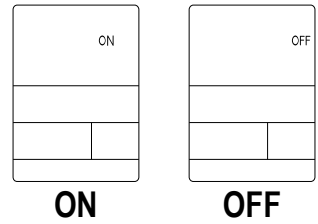

Selecting temperature scale

- Press the [C/F] buttons to switch between temperature scales.

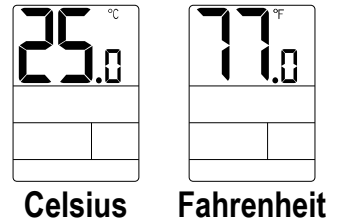

Adjusting the Set point temperature

In One set point configuration:

- Press the [+] or [-] buttons once to view the set point temperature.
- Press again to adjust the set point.

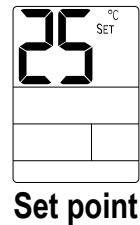

In Two set points configuration:

- Press the [+] or [-] buttons once – “CL” and the set point temperature for cooling will appear on display.
- Use the [+] or [-] buttons to adjust the set point for cooling.
- Press the [Mode] button or wait 3 seconds – “Ht” and the set point temperature for heating will appear on display.
- Use the [+] or [-] buttons to adjust the set point for heating.

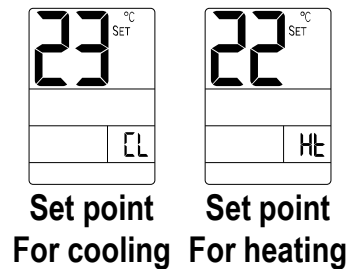

Note: The set point for cooling must be higher than the set point for heating.

Operating instructions (Cont')

Selecting system mode

- Press the [Mode] button to switch between system modes.

Notes:

- During demand for cooling or heating, the active mode will flash.
- In Auto mode, the active mode icon (Cool or Heat) will appear on display.
- Auto mode is not available in 2-Pipe system configuration.

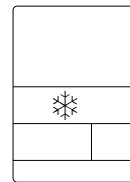

Cool

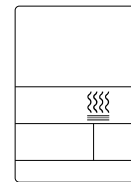

Heat

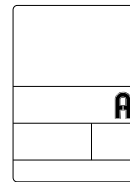

Auto

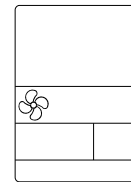

Fan only

Selecting Fan speeds (for 2 and 3 fan speeds configuration)

- Press the [Fan] button to switch between fan speeds.

Notes:

- In Auto speed, the active fan speed icon will appear on display.
- Medium speed available in 3 speeds config.

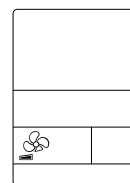

Low

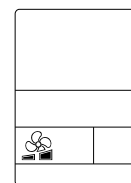

Medium

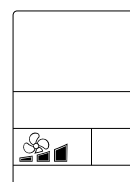

High

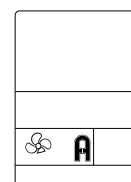

Auto

Turning Auto fan ON or OFF (fan on demand)

In 1 speed configuration:

- Press the [Fan] button to turn Auto fan ON or OFF.

In 2 and 3 speeds configuration:

Press and hold the [Fan] button for 5 seconds to turn Auto fan ON or OFF.

- When ON, the fan will run on demand for cooling or heating,
- When OFF, the fan will run continuously.

Note: Auto fan cannot be selected in Fan only mode.

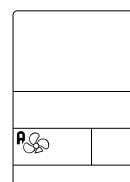

Auto fan
OFF

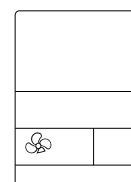

Auto fan
ON

Locking the thermostat buttons

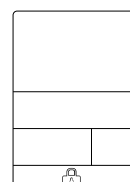

Lock
mode



Lock
indication

Operating instructions (Cont')

Resetting filter alarm

- Press and hold the [Fan] button for 15 seconds to reset filter alarm.

Sleep mode

- Press and hold the [mode] button for 5 seconds to activate sleep mode.
- Press the mode button again (short press) to deactivate sleep mode.
- When sleep mode is activated, the thermostat will use comfort set point temperatures offset set by technician.

Please refer to objects "SleepCoolSetpointOffset" and "SleepHeatSetpointOffset" in the technician setting section of this manual.

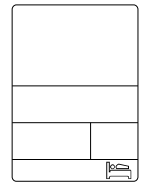

Sleep mode

Economy mode

- Economy mode can be activated by triggering the window contact, the door switch or the PIR sensor (passive infrared sensor).
- When Economy mode is active, the thermostat will use special economy set points for cooling and heating set by technician.

Please refer to objects "EconomySetpointinHeat" and "EconomySetpointinCool" in the technician setting section of this manual.

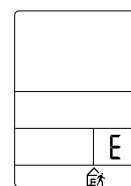

Economy by window contact



Economy by PIR

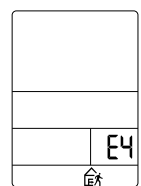

Economy by door switch

Freeze Protection

The Freeze protection feature will not allow the room temperature to drop below predefined cut-in temperature. Depending on which configuration the system is operating under (W/WO Heat pump) this feature will force the system to operate in heat mode and activate the fan. This feature will take effect when the thermostat is either ON or OFF. When the room temperature rises above the predefined cut-out temperature, the thermostat will return to its previous state.

When freeze protection is activated, the display alternates between "AL" and room temperature.

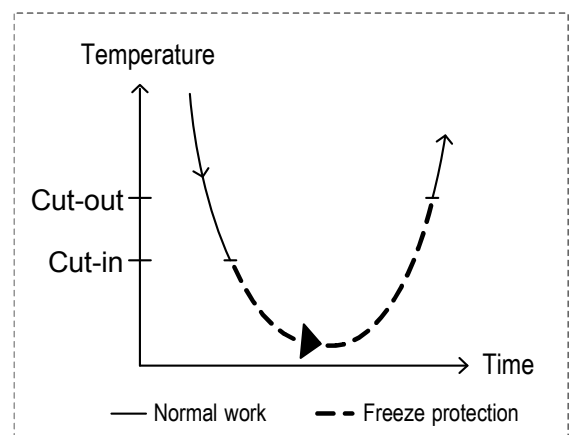

Installation

The ETNC24 is designed for wall mounting in the room to be controlled. It should be located where the occupant can easily read the LCD display and use the controls and where the built in PIR occupancy sensor can easily detect any movement in the room (consider PIR detection area below). If the built in temperature sensor is being used to measure room temperature, the module should be placed where the temperature is representative of the general room conditions. Cold or warm air draughts; radiant heat and direct sunlight should be avoided.

General points to follow:

- Disconnect power to the main board before installing the unit.
- The standard height to install this unit is 1.5 meter (5 feet) from the floor.

Installation procedure:

- Separate the front panel from back panel by pressing the tongue located in the top of the unit and pull the back panel out.
- Line the back panel up against the wall or flat surface. Install three screws as required.
- Make electrical connections as shown on enclosed electrical wiring diagram.
- Install the cove to the back panel; first the two bottom tabs and then the top tongue. Push until tight against the wall.

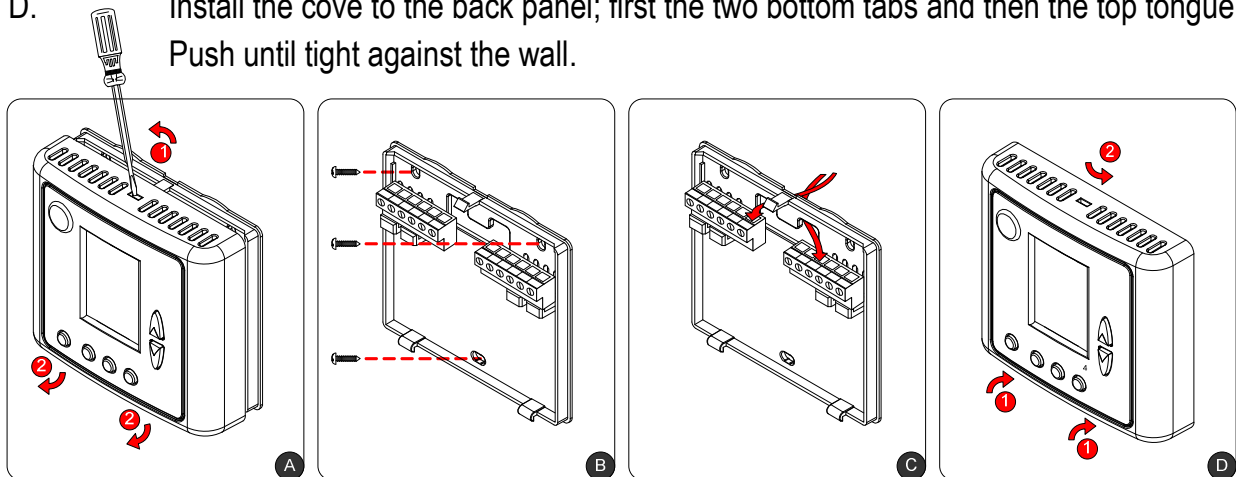

PIR detection area

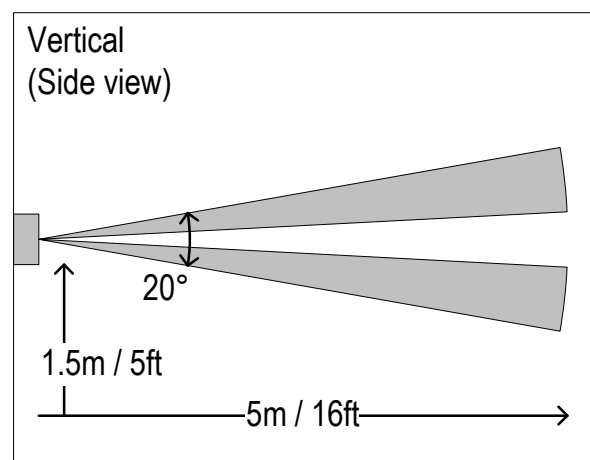
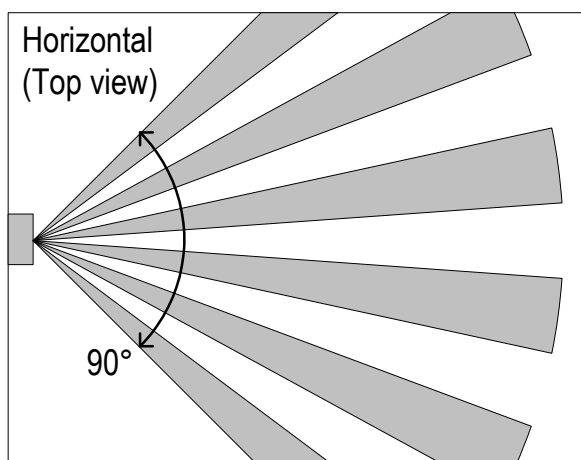

Wiring

4-Pipe system (with auto change over mode)

11	High speed
12	Medium speed
13	Low speed
14	Heat element
T1	*External sensor / Soft start sensor / Door switch
0	
B	Communication RS485 BACnet protocol
A	
In1	**Sensor / Remote switch / External PIR
0	
15	Cool valve
16	Heat valve
C	Main supply 24VAC
R	

2-Pipe system (without auto change over mode)

11	High speed
12	Medium speed
13	Low speed
14	Heat element
T1	*External sensor / Soft start sensor / Door switch
0	
B	Communication RS485 BACnet protocol
A	
In1	**Sensor / Remote switch / External PIR
0	
15	Cool/Heat valve
16	Not in use
C	Main supply 24VAC
R	

All outputs 24VAC, 0.5A max.

Selection of 2-Pipe or 4-Pipe system by DIP switch

(See DIP switch SW1 configuration)

*Options for T1,0 terminals:

- Not in use
 - External sensor
 - Soft start in heat sensor
 - Door switch (Hotel mode)
- (See "P08" section in technician settings)

**Options for In1,0 terminals:

- Not in use
 - T2 (Change over sensor)
 - T3 (Soft start in heat sensor)
 - Remote On/Off switch
 - Remote Economy switch
 - Window Contact
 - External Passive Infrared detector (PIR)
- (See "P09" section in technician settings)

Jumpers

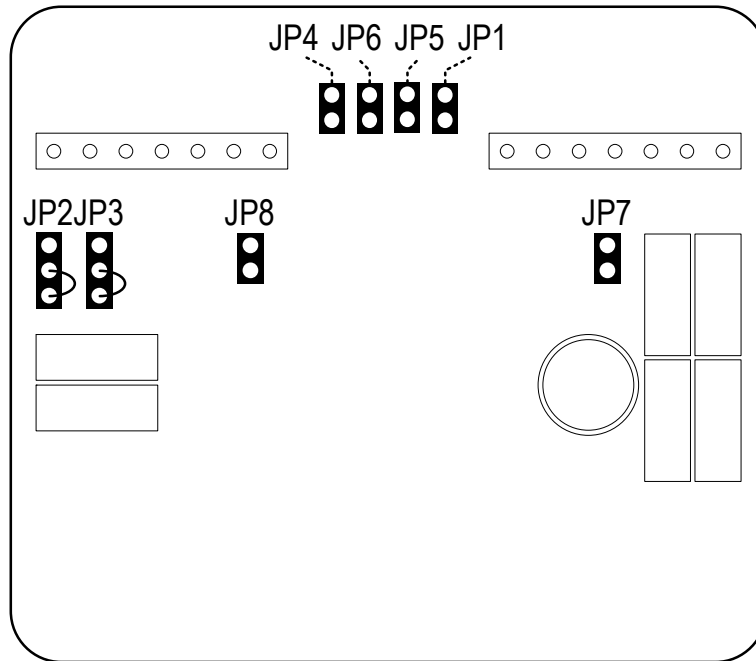

JP1 - End of line resistor (120Ω)

- Open - Not End of line
- Close - End of line

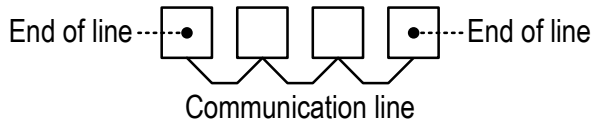

JP2, JP3 – Not in use

Must remain at factory default position

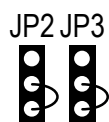

JP4 – Temperature display

- Open - Ambient & Set point
- Close - Set point only

JP5 – Enable/Disable PIR detector

- Open - Enable PIR detector
- Close - Disable PIR detector

JP6 – No valve configuration

- Open - Disable No valve configuration
 - Close - Enable No valve configuration
- Note: in no valve configuration, the fan will run only on demand for cooling or heating.

JP7 – Chilled beam configuration

- Open - Disable Chilled beam configuration
 - Close - Enable Chilled beam configuration
- Note: in Chilled beam configuration, the fan will remain OFF in cooling mode.

JP8 – Floor heating configuration

- Open - Disable Floor heat configuration
 - Close - Enable Floor heat configuration
- Note: in Floor heat configuration, the fan will remain OFF in 1st stage heating (floor heating).

DIP switch SW1 - configuration

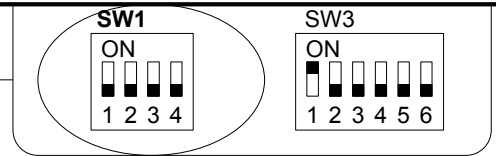

Number of fan speeds

- Use DIP Switches SW1.1 and SW1.2 to select number of fan speeds:

- 1 speed: SW1.1 – ON SW1.2 – OFF
- 2 speeds: SW1.1 – OFF SW1.2 – ON
- 3 speeds: SW1.1 – OFF SW1.2 – OFF

Default = 3 Speeds

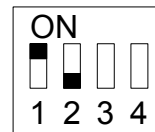

1 Speed

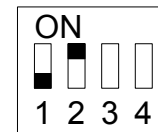

2 Speeds



3 Speeds

2-Pipe (without auto change over mode) or 4-Pipe (with auto change over mode) system

- Use DIP Switch SW1.3 to select between 2-Pipe and 4-Pipe system configuration:

- 2-Pipe: SW1.3 – OFF
- 4-Pipe: SW1.3 – ON

Default = 2-Pipe

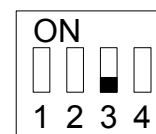

2-Pipe

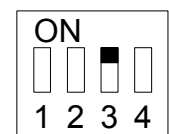

4-Pipe

Enable/Disable Electric heater on 2nd stage heating

- Use DIP Switch SW1.4 to enable or disable the operation of electric heater on 2nd stage heating.

- Enable: SW1.4 – ON
- Disable: SW1.4 – OFF

Default = Disable

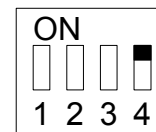

Enable
2nd stage
heat

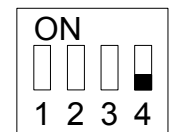

Disable
2nd stage
heat

DIP switch SW3 – MAC Address

- Use DIP Switches SW3.1...SW3.8 to define unique communication MAC address for each unit in communication line (range 1 to 256).

Examples:

- MAC Address 1: 1 – ON 2...8 – OFF
- MAC Address 2: 2 – ON 1, 3...8 – OFF
- MAC Address 3: 1,2 – ON 3...8 – OFF

Use the following MAC address table for all combinations.

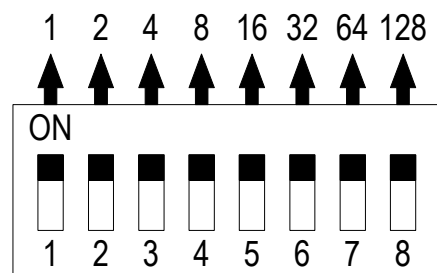
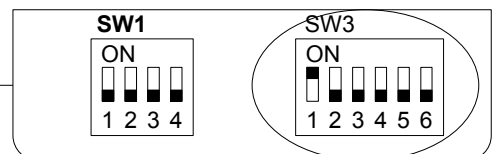

MAC Address table (1-127)

Switches ON								Switches ON								Switches ON								Switches ON																																				
1	2	3	4	5	6	7	8	1	2	3	4	5	6	7	8	1	2	3	4	5	6	7	8	1	2	3	4	5	6	7	8																													
0	Not in use														32															64															96															
1	■							33	■																				65	■															97	■														
2		■						34		■																			66		■														98		■													
3	■	■						35	■	■																			67	■	■														99	■	■													
4			■					36			■																		68			■													100			■												
5	■		■					37	■		■																		69	■		■													101	■		■												
6		■	■					38		■	■																		70		■	■													102		■	■												
7	■	■	■					39	■	■	■																		71	■	■	■													103	■	■	■												
8				■				40				■																	72				■												104				■											
9	■			■				41	■			■																	73	■			■												105	■			■											
10		■		■				42		■		■																	74		■		■												106		■		■											
11	■	■		■				43	■	■		■																	75	■	■		■												107	■	■		■											
12			■	■				44			■	■																	76			■	■												108			■	■											
13	■		■	■				45	■		■	■																	77	■		■	■												109	■		■	■											
14		■	■	■				46		■	■	■																	78		■	■	■												110		■	■	■											
15	■	■	■	■				47	■	■	■	■																	79	■	■	■	■												111	■	■	■	■											
16					■			48				■																	80					■											112					■										
17	■			■				49	■			■																	81	■			■												113	■			■											
18		■		■				50		■		■																	82		■		■												114		■		■											
19	■	■		■				51	■	■		■																	83	■	■		■												115	■	■		■											
20			■	■				52			■	■																	84			■	■												116			■	■											
21	■		■	■				53	■		■	■																	85	■		■	■												117	■		■	■											
22		■	■	■				54		■	■	■																	86		■	■	■												118		■	■	■											
23	■	■	■	■				55	■	■	■	■																	87	■	■	■	■												119	■	■	■	■											
24				■	■			56				■	■																88				■	■											120				■	■										
25	■			■	■			57	■			■	■															89	■			■	■											121	■			■	■											
26		■		■	■			58		■		■	■																90		■		■	■											122		■		■	■										
27	■	■		■	■			59	■	■		■	■																91	■	■		■	■											123	■	■		■	■										
28			■	■	■			60			■	■	■																92			■	■	■											124			■	■	■										
29	■		■	■	■			61	■		■	■	■																93	■		■	■	■											125	■		■	■	■										
30		■	■	■	■			62		■	■	■	■																94		■	■	■	■											126		■	■	■	■										
31	■	■	■	■	■			63	■	■	■	■	■																95	■	■	■	■	■											127	■	■	■	■	■										

MAC Address table (128-255)

Switches ON		Switches ON		Switches ON		Switches ON																										
1	2	3	4	5	6	7	8	1	2	3	4	5	6	7	8	1	2	3	4	5	6	7	8	1	2	3	4	5	6	7	8	
128							■	160						■	■	192							■	■	224				■	■	■	■
129	■						■	161	■					■	■	193	■						■	■	225	■			■	■	■	■
130		■					■	162		■				■	■	194		■					■	■	226		■			■	■	■
131	■	■					■	163	■	■				■	■	195	■	■					■	■	227	■	■			■	■	■
132			■				■	164			■			■	■	196			■				■	■	228			■			■	■
133	■		■				■	165	■	■				■	■	197	■		■				■	■	229	■		■			■	■
134		■	■				■	166		■	■			■	■	198		■	■				■	■	230		■	■			■	■
135	■	■	■				■	167	■	■	■			■	■	199	■	■					■	■	231	■	■			■	■	■
136				■			■	168				■		■	■	200			■				■	■	232			■			■	■
137	■		■				■	169	■		■			■	■	201	■		■				■	■	233	■		■			■	■
138		■		■			■	170		■		■		■	■	202		■		■			■	■	234		■		■		■	■
139	■	■	■				■	171	■	■				■	■	203	■	■					■	■	235	■	■			■	■	■
140			■				■	172			■			■	■	204		■	■				■	■	236			■			■	■
141	■		■				■	173	■		■			■	■	205	■		■				■	■	237	■		■			■	■
142		■	■				■	174		■	■			■	■	206		■	■				■	■	238		■	■			■	■
143	■	■	■				■	175	■	■	■			■	■	207	■	■					■	■	239	■	■			■	■	■
144				■			■	176				■		■	■	208			■				■	■	240				■		■	■
145	■			■			■	177	■			■		■	■	209	■		■				■	■	241	■			■		■	■
146		■		■			■	178		■		■		■	■	210		■		■			■	■	242		■		■		■	■
147	■	■		■			■	179	■	■				■	■	211	■	■					■	■	243	■	■			■	■	■
148			■		■		■	180			■			■	■	212		■		■			■	■	244		■		■		■	■
149	■		■		■		■	181	■		■			■	■	213	■		■				■	■	245	■		■		■	■	■
150		■	■		■		■	182		■	■			■	■	214		■	■				■	■	246		■		■		■	■
151	■	■	■		■		■	183	■	■				■	■	215	■	■					■	■	247	■	■			■	■	■
152				■			■	184				■		■	■	216			■				■	■	248			■			■	■
153	■			■			■	185	■			■		■	■	217	■		■				■	■	249	■		■			■	■
154		■		■			■	186		■		■		■	■	218		■		■			■	■	250		■		■		■	■
155	■	■		■			■	187	■	■				■	■	219	■	■					■	■	251	■	■			■	■	■
156			■		■		■	188			■			■	■	220		■	■				■	■	252		■		■		■	■
157	■		■		■		■	189	■		■			■	■	221	■		■				■	■	253	■		■		■	■	■
158		■		■			■	190		■		■		■	■	222		■	■				■	■	254		■		■		■	■
159	■	■		■			■	191	■	■				■	■	223	■	■					■	■	255	■	■			■	■	■

Technician Settings

Enter technician settings mode:

- Press and hold the [-] button and while holding it, press and hold the [Mode] button for 7 seconds to enter technician settings mode.
- "P01" will appear on display.

View objects and make adjustments:

- Use the [Mode] button to step forward between different objects (parameters).
- Use the [Fan] button to step backward between different objects (parameters).
- Press the [On/Off] button to exit technician settings and return to normal display.
- If no button is pressed for 60 seconds, the thermostat will automatically exit technician settings and return to normal display.
- Use the [+] and [-] buttons to make adjustments when required.

P01 – Offset for temperature readings calibration

Range: -6...+6°C / -9...+9°F.

Default: 0°C / 0°F.

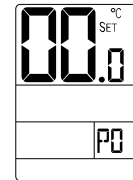

Offset
(°C)



Offset
(°F)

P02 – Set point limit for cooling

Range: 5...35°C / 41...90°F.

Default: 5°C / 35°F.

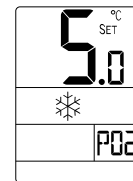

Limit cool
(°C)

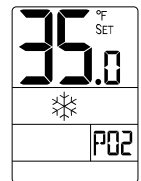

Limit cool
(°F)

P03 – Set point limit for heating

Range: 5...35°C / 41...90°F.

Default: 35°C / 90°F.

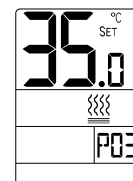

Limit heat
(°C)

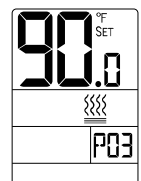

Limit heat
(°F)

Technician Settings (Cont')

P04 – Lock the [Fan] button

“LF” + “ON” [Fan] button Locked
 “LF” + “OFF” [Fan] button unlocked

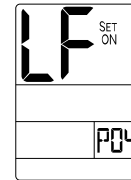

[Fan]
locked

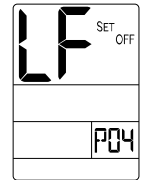

[Fan]
unlocked

P05 – Lock the [Mode] button

“L1” + “ON” [Fan] button Locked
 “L1” + “OFF” [Fan] button unlocked

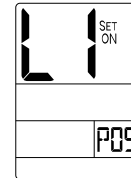

[Mode]
locked

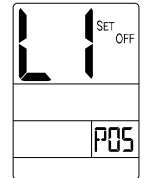

[Mode]
unlocked

P06 – Lock the [On/Off] button

“L0” + “ON” [On/Off] button Locked
 “L0” + “OFF” [On/Off] button unlocked



[On/Off]
locked

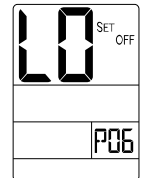

[On/Off]
unlocked

P07 – Lock the [+] and [-] buttons (Set buttons)

“LS” + “ON” [+] and [-] buttons Locked
 “LS” + “OFF” [+] and [-] buttons unlocked

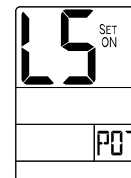

[+] and [-]
locked

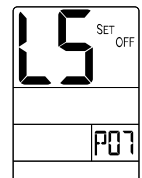

[+] and [-]
unlocked

P08 – Functionality of T1 terminals and Office or Hotel configuration

“00”, “01”, “02” - Office config.:

“00” - T1 terminals are not in use

“01” - External sensor

“02” - Soft start in heat sensor

“03” - Hotel config.:

“03” - Door switch

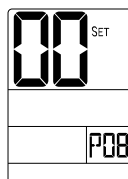

T1 terminals
Not in use

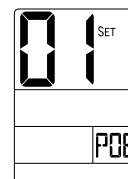

T1 sensor
(External sensor)

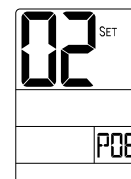

Soft start
sensor

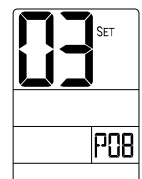

Door switch
(hotel config.)

Technician Settings (Cont')

P09 – Functionality of In1,0 terminals

- "00" - In1,0 terminals are not in use
- "01" - T2 (Change over sensor)
- "02" - *T3 (Soft start in heat sensor)
- "03" - Remote On/Off switch
- "04" - Remote Economy switch
- "05" - External Passive Infrared detector (PIR)

* Where T1 terminals are used for external sensor, the In1,0 terminals can be used for T3 sensor.

"In1,0" terminals Not in use	T2 sensor (change over)	T3 sensor (Soft start)
Remote On/Off	Remote Economy	External PIR sensor

P10 – Window contact (terminals In1,0) polarity

- "01" - Normally open
- "00" - Normally close

Win. contact Normally close	Win. contact Normally open

P11 – Window contact delay time

- Range: 0...999 seconds.
- Default: 60 seconds.

Window contact delay time (sec.)

P12 – Door switch (terminals T1,0) polarity

- "01" - Normally open
- "00" - Normally close

Door switch Normally close	Door switch Normally open

P13 – Door switch delay time

- Range: 0...999 seconds.
- Default: 180 seconds.

Door switch delay time (sec.)

Technician Settings (Cont')

P14 – Enable/Disable Auto change over mode

- “00” - Disable Auto change over mode
- “01” - Enable Auto change over mode

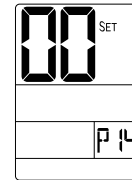

Disable
Auto mode

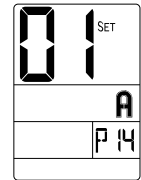

Enable
Auto mode

P15 – Occupancy sensor logic (PIR)

- “00” - Thermostat turns off when unoccupied and back on when re-occupied.
- “01” - Thermostat turns off when unoccupied and remains off when re-occupied.
- “02” - Thermostat uses economy set points.

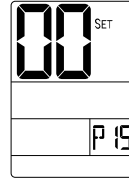

Unocc. – Off
Re-occ. - On

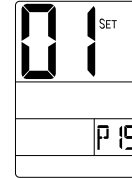

Unocc. – Off
Re-occ. - Off

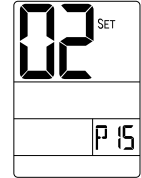

Economy
set points

P16 – Enable/Disable Occupancy sensor

- “00” - Disable
- “01” - Enable

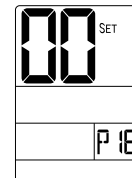

Disable
occ. sensor

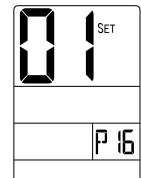

Enable
occ. sensor

P17 – PIR (occupancy sensor) delay time before switching to unoccupied mode (ON delay)

- Range: 0...250 minutes.
- Default: 20 minutes.

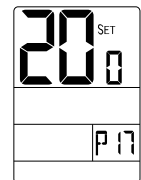

PIR ON delay
(sec.)

P19 – PIR (Occupancy sensor) polarity

- “00” - Normally open
- “01” - Normally close

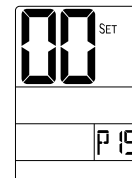

PIR
Normally open

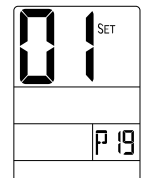

PIR
Normally close

Technician Settings (Cont')

P22 – Sleep mode time delay

Range: 0...600 minutes

Default: 60 minutes

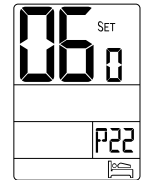

Sleep mode time delay (minutes)

P23 – Sleep mode offset in cooling

Range: 0...9°C / 0...18°F

Default: 2°C / 2°F

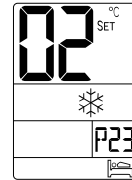

Sleep offset in cooling (°C)



Sleep offset in cooling (°F)

P24 – Sleep mode offset in heating

Range: -9...0°C / -18...0°F

Default: -2°C / -2°F

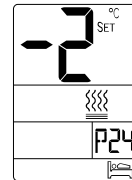

Sleep offset in heating (°C)

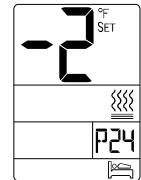

Sleep offset in heating (°F)

P25 – Economy set point for cooling

Range: 5...35°C / 41...90°F.

Default: 30°C / 86°F.



EC set point In cooling (°C)

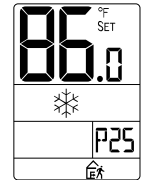

EC set point In cooling (°F)

P26 – Economy set point for heating

Range: 5...35°C / 41...90°F.

Default: 10°C / 50°F.

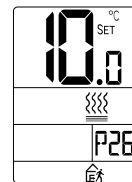

EC set point In heating (°C)

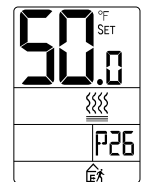

EC set point In heating (°F)

Technician Settings (Cont')

P29 – LCD Backlight ON or OFF

“bL” + “ON” LCD Backlight ON
“bL” + “OFF” LCD Backlight OFF

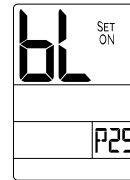

**Backlight
ON**

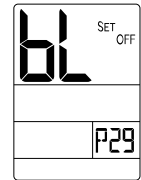

**Backlight
OFF**

P30 – Beeper ON or OFF

“bP” + “ON” Beeper ON
“bP” + “OFF” Beeper OFF

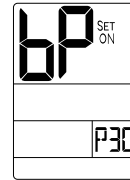

**Beeper
ON**

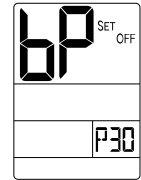

**Beeper
OFF**

Technician Settings (Cont')

P31 – P34

Fan on/off delay
with fan on demand
(auto fan) active.

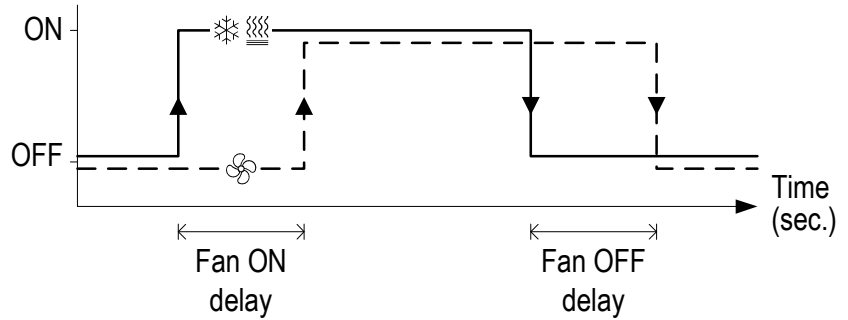

P31 – Fan ON delay in cooling (seconds)

Range: 0...120 seconds

Default: 0 seconds (no delay)

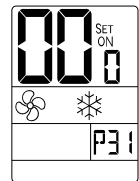

Fan ON delay
in cooling (seconds)

P32 – Fan OFF delay in cooling (seconds)

Range: 0...120 seconds

Default: 0 seconds (no delay)

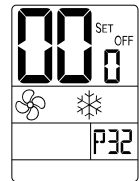

Fan OFF delay
in cooling (seconds)

P33 – Fan ON delay in heating (seconds)

Range: 0...120 seconds

Default: 0 seconds (no delay)

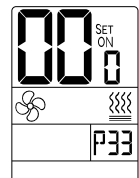

Fan ON delay
in heating (seconds)

P34 – Fan OFF delay in heating (seconds)

Range: 0...120 seconds

Default: 30 seconds

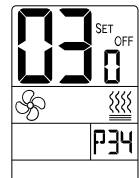

Fan OFF delay
in heating (seconds)

Technician Settings (Cont')

P35 – Enable/Disable Freeze protection

“FP” + “ON” Enable Freeze protection
“FP” + “OFF” Disable Freeze protection

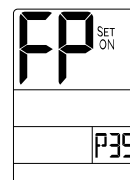

Enable freeze protection

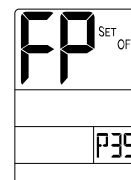

Disable freeze protection

P36 – Freeze protection cut-in set point

Range: 8...15°C / 46...59°F
Default: 8°C / 46°F

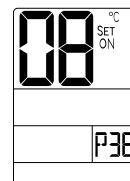

FP cut-in set point (°C)

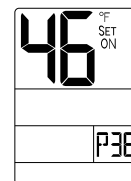

FP cut-in set point (°F)

P37 – Freeze protection cut-out set point

Range: 10...17°C / 50...63°F
Default: 10°C / 50°F

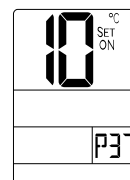

FP cut-out set point (°C)

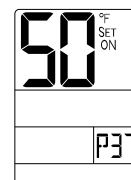

FP cut-out set point (°F)

Technician Settings (Cont')

P40 – View filter counter (hours) – Read only

Range: 0...999 hours

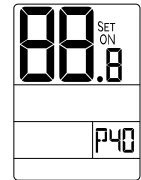

**View filter
Counter (hours)**

P41 – Reset filter time

"Fr" + "OFF" No action (keep counting)

"Fr" + "ON" Reset filter counter

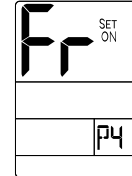

**Reset filter
counter**

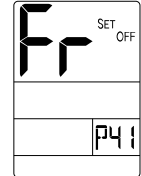

**No action
(keep counting)**

P42 – Adjust filter alarm delay time counter (hours)

Range: 0...999 hours

Default: 0 hours (0 = Disable)

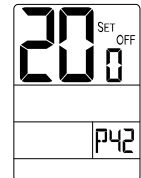

**Adjust filter alarm
delay time (hours)**

Technician Settings (Cont')

P43 – P44

Soft start in heat
with fan on demand
(auto fan) active.

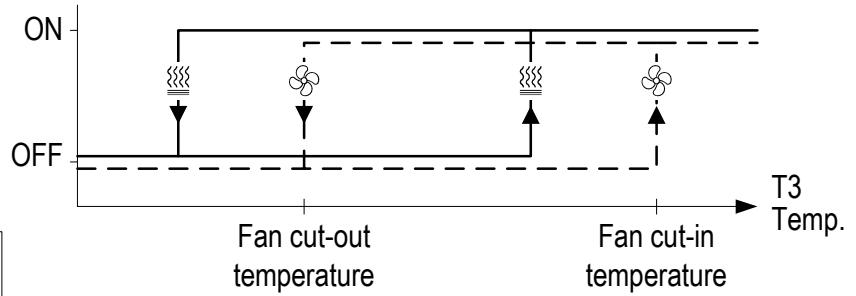

P43 – Soft start in heat – cut-in temperature

The fan will not start before the temperature on T3 sensor reaches the cut-in temperature.

Range: 14...37°C / 57...99°F

Default: 36°C / 97°F

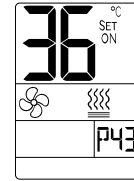

Soft start heat
Cut-in (°C)

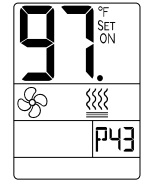

Soft start heat
Cut-in (°F)

P44 – Soft start in heat – cut-out temperature

The fan will stop if the temperature on T3 sensor drops below the cut-out temperature.

Range: 14...37°C / 54...95°F

Default: 32°C / 90°F

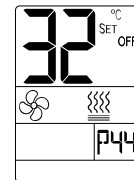

Soft start heat
Cut-out (°C)

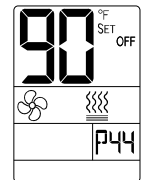

Soft start heat
Cut-out (°F)

Technician Settings (Cont')

P45 – P46

Cool differential band / offset
(with cool differential band offset = 0)

— Compressor / Valve

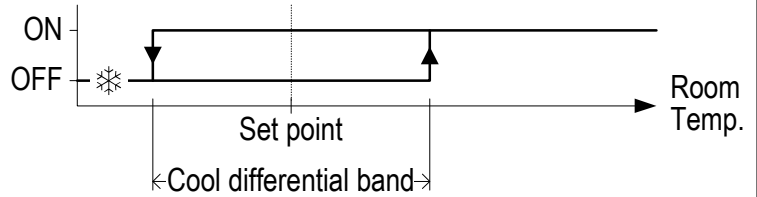

P45 – P46

Cool differential band / offset
(with cool differential band offset \neq 0)

— Compressor / Valve

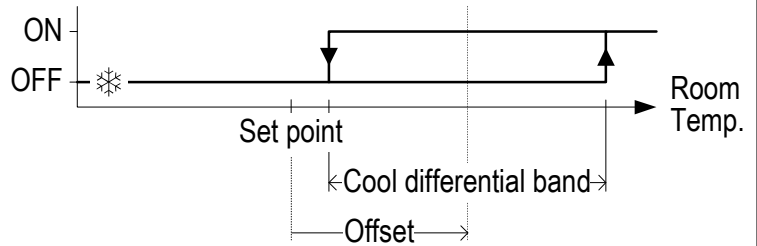

P45 – Cool differential band

Range: 0...5°C / 0...10°F

Default: 1°C / 2°F



Cool diff.
band (°C)



Cool diff.
band (°F)

P46 – Cool differential band offset

Range: 0...5°C / 0...10°F

Default: 0°C / 0°F



Cool diff. band
offset (°C)



Cool diff. band
offset (°F)

Technician Settings (Cont')

P47-48

Heat differential band / offset
(with heat differential band offset = 0)

— Compressor / Valve

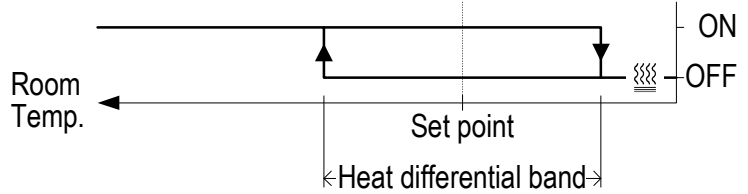

P47-48

Heat differential band / offset
(with heat differential band offset ≠ 0)

— Compressor / Valve

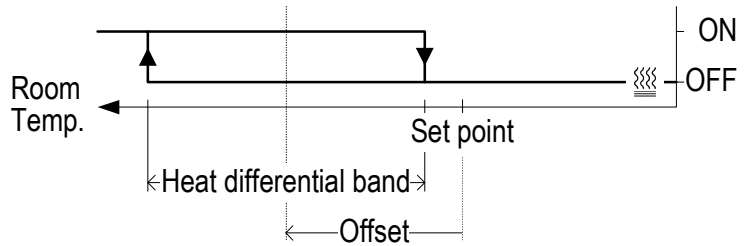

P47 – Heat differential band

Range: 0...5°C / 0...10°F

Default: 1°C / 2°F

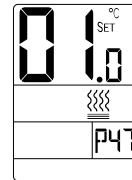

Heat diff.
band (°C)

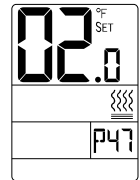

Heat diff.
band (°F)

P48 – Heat differential band offset

Range: -5...0°C / -10...0°F

Default: 0°C / 0°F

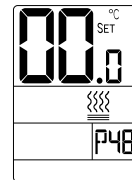

Heat diff. band
offset (°C)

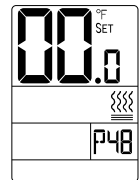

Heat diff. band
offset (°F)

Technician Settings (Cont')

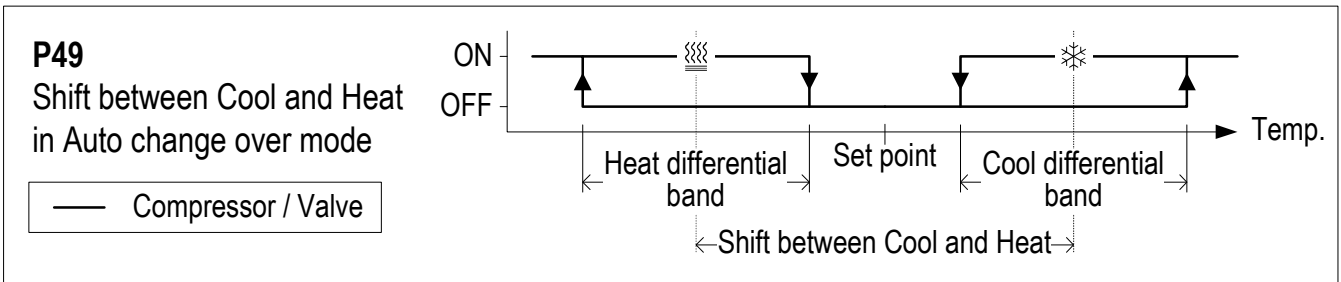

P49 – Shift between Cool and Heat in Auto change over mode

Range: 0...10°C / 0...20°F

Default: 2°C / 4°F



Shift between
Cool & Heat (°C)

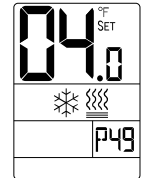

Shift between
Cool & Heat (°F)

P51 – Shift between Heating stages

Range: 0...10°C / 0...20°F

Default: 2°C / 4°F

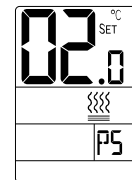

Shift between
Heating stg. (°C)

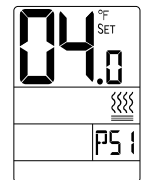

Shift between
Heating stg. (°F)

P83 – View T2 temperature sensor readings

Note: If T2 is not connected, -9.8°C / -9.8°F will appear on display

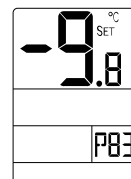

T2 Sensor
Not connected

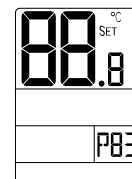

T2 Sensor
readings (°C)

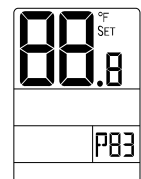

T2 Sensor
readings (°F)

P84 – View T3 temperature sensor readings

Note: If T3 is not connected, -9.8°C / -9.8°F will appear on display



T3 Sensor
Not connected

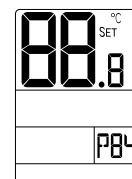

T3 Sensor
readings (°C)

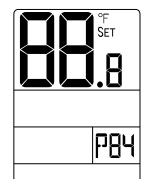

T3 Sensor
readings (°F)

Technician Settings (Cont')

P99 – One or Two set points (for cool and for heat)

“00” - One set point for cooling and heating

“01” - two set points – one for cool and one for heat

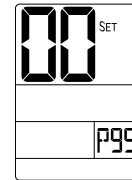

One
set point

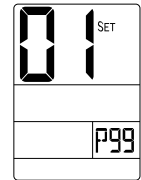

Two
set points

Press the [Mode] button or wait 60 seconds to return to normal display.

Restore defaults

Reset thermostat to factory settings

- Press and the [Mode], [Fan] and [On/Off] buttons simultaneously for 10 seconds to reset the thermostat to factory settings.

Remote control (option)

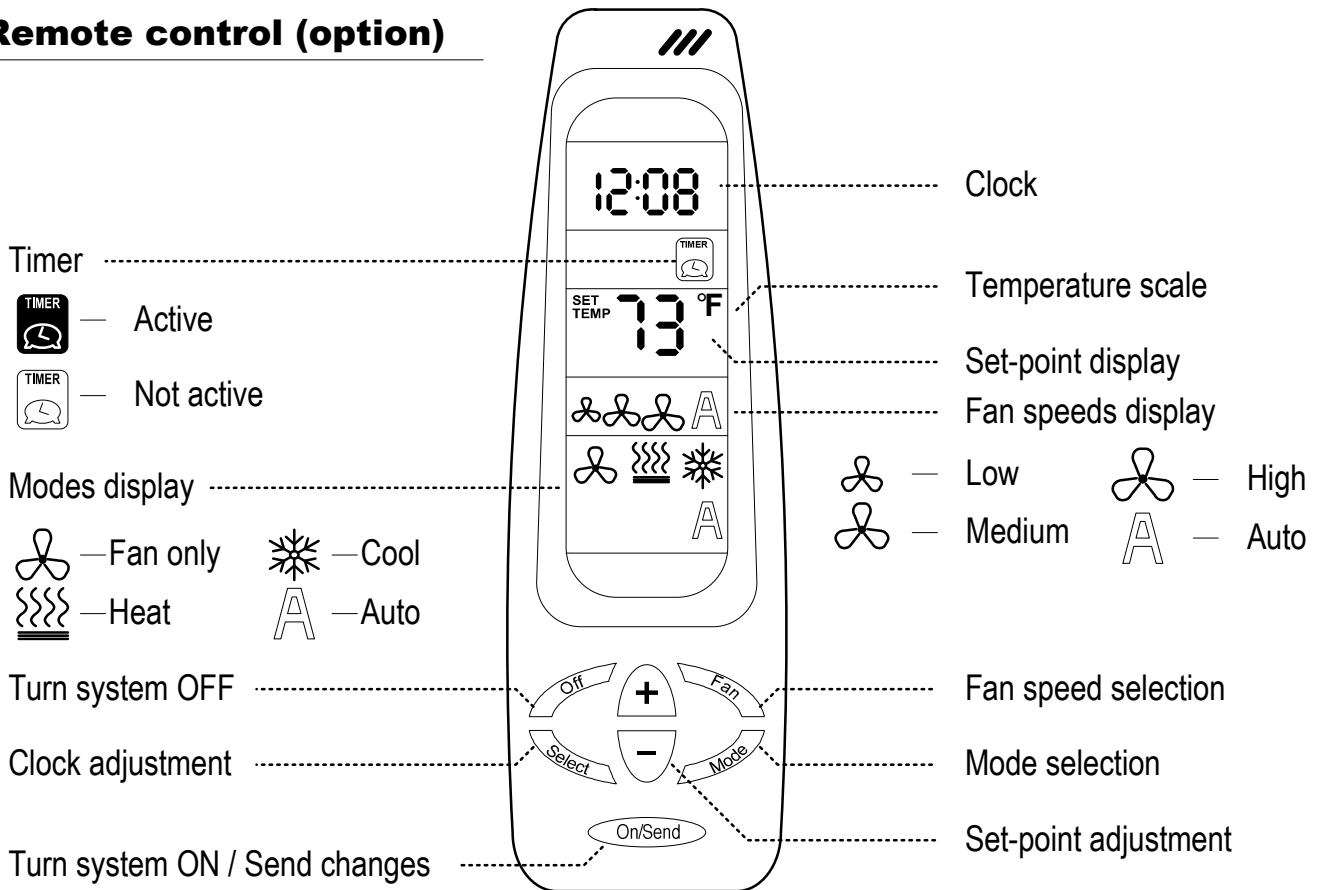

Real Time Clock and Day

- Press the "Select" button – "CLOCK SET" will flash.
- Press the [+] or [-] buttons - the hours will flash.
- Adjust the hours using the [+] or [-] buttons.
- Press the [Select] again - minutes will flash.
- Adjust the minutes using the [+] or [-] buttons.
- Press the [Select] again to return to normal display.
- Press the [On/Send] button to send information to the thermostat.

Batteries Replacement

When the batteries are low, the display of the remote control will dim.

- Pull the batteries cover down to reveal the batteries.
- Remove the old batteries and **wait at least 10 minutes before installing 2 new AAA batteries.**
- Reassemble the batteries cover.

Important: The remote control will not operate unless at least 10 minutes pass between removing the old batteries and installing the new ones.

Timer

Start Time:

- Press the [Select] button twice – "PROGRAM & START" will flash on display.
- Press the [Select] button - the hours will flash.
- Adjust the hours using the [+] or [-] buttons.
- Press the [Select] button - the minutes will flash.
- Adjust the minutes using the [+] or [-] buttons.

Stop Time:

- Press the [Select] button – "PROGRAM & STOP" will flash on display.
- Press the [Select] button - the hours will flash.
- Adjust the hours using the [+] or [-] buttons.
- Press the [Select] button - the minutes will flash.
- Adjust the minutes using the [+] or [-] buttons.
- Press the [Select] button - the TIMER will blink
- Select TIMER ON (black icon) or OFF (white icon) using the [+] or [-] buttons.
- Press the [On/Send] button to send the information to the thermostat.



Tel: +972-3-9626462

Fax: +972-3-9626620

support@meitavtec.com

www.meitavtec.com