



# FPC-02 Series

## Installation and Operating manual

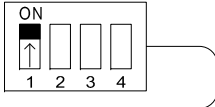
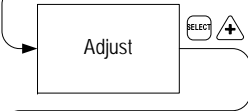
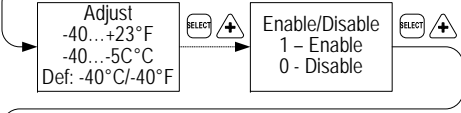
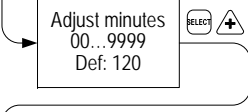

## FPC-02 | Fast Reference Guide

### Technician Settings

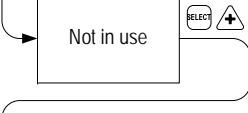
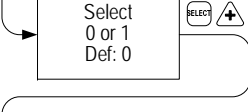
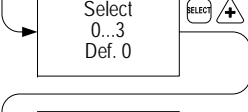
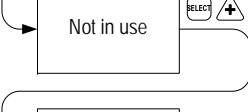
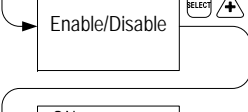
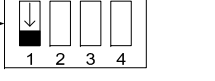
<b>Enter technician settings</b>		Move DIP switch S1 located on the side of thermostat to ON position.
<b>P01 Temperature set point</b>		Adjust the temperature set point. Above this temperature the outputs to the heaters will not be activated. Range: -15°C - +15°C. <b>Default +3°C (5°F - +59°F. Default +38°F)</b> <b>Note: the temperature is measured by the PYROULS</b>
<b>P02 Low limit Temperature</b>		Adjust and enable/disable the low limit temperature. When temperature on snow sensor drops below the low temperature limit, the heating system will stop.
<b>P03 Time delay</b>		Adjust the time delay before stopping the heaters. Note 1. The time delay countdown will start when the temperature value from the temp. sensor will rise above the Temp. Set-Point. Note 2. The staggering sequence will continue during the time delay period.
<b>P04 Manual ON</b>		Adjust the "Manual ON" mode time period. The delay time parameter defines a time frame in which the heaters remain ON after receiving a "Manual ON" command.
<b>P05 Not in use</b>		Not in use
<b>P06 Number of Temp.sensors</b>		Enable or disable a second temperature sensor for the system (aquastat)
<b>P07 Logic of sensors And outputs</b>		Define heaters control by the temperature sensors "0" - 1-5 by PYROULS. 4 & 5 operate together. "2" - 1-5 by aquastat . Temperature display blank. Options 1 and 3 are not relevant.
<b>P08 Not in use</b>		Not in use
<b>P09 Test mode (commissioning)</b>		Turn ON test conditions to check the functionality of the system regardless of sensors parameters. Note: If the technician did not manually exit test/commissioning mode, the unit will automatically return to normal mode after 5 hours.
<b>Save changes and Exit technician settings</b>		Move DIP switch S1 located on the side of thermostat to OFF position.

**Important: Changes made to technician parameters will not take effect as long as DIP switch S1 is ON.**

### Operating Manual

#### Turning the system ON and OFF

- Press and hold the [ON] button for 0.5 seconds to turn the system ON or OFF.
- The words "ON" or "OFF" will appear on display.

#### Selecting temperature scale

- Press the [+] button for Celsius.
- Press the [-] button for Fahrenheit.

#### Selecting Automatic or Manual mode

- Press the [SELECT] button to switch between modes:

**"Automatic"** Heating will start and stop automatically depending on the set point and ambient temperatures.

**"Manual ON"** Heating will start regardless of the set point and ambient temperatures and will stop after a preset time (pls. refer to the "Manual ON" section in the technician settings).

Note: Mode will always return to "Automatic" after switching the unit OFF and ON.

#### Snow flake icon and digital time indication



A solid snow flake icon will appear on display during normal heaters operation.

A blinking snow flake icon will appear on display during heaters off delay or when manual mode is activated. The digital clock will count down the remaining time until the heaters are turned off.

The snow flake icon will disappear from display as long as the heaters are turned off.

### Technician Settings (cont')

#### DIP switch S1 – Enter technician settings mode / Restore default values

- Move DIP switch S1 to ON position to enter technician settings mode (see table on the left).
- In order to restore default settings, press and hold the [ON] button for 10 seconds.
- Move DIP switch S1 back to OFF position.

#### DIP switch S2 - Short measuring times (test only)

- "ON" - Short measuring times – for test/commissioning only (measuring times will be divided to 60).
- "OFF" - Normal operation.

Short measuring times: A real 1 hour will take 1 minute and a real 1 minute will take 1 second.

**DIP switches S3 and S4 – Must be in OFF position.**



T. (856) 2882882 | T. +972-3-9626462 | F. +972-3-9626620  
support@meitavtec.com | www.meitavtec.com

## Index

---

<b>Introduction</b> .....	<b>3</b>
<b>FPC-02 Installation notes</b> .....	<b>4</b>
Wiring the FPC-02-120V, FPC-02-120V-MDB .....	5
Wiring the FPC-02-240V, FPC-02-240V-MDB .....	6
<b>Operating instructions</b> .....	<b>7</b>
Turning the system ON and OFF .....	7
Selecting temperature scale.....	7
Selecting Automatic or Manual mode .....	7
Heater indication.....	7
Snow flake icon and digital time indication.....	7
<b>Technician settings</b> .....	<b>8</b>
Enter technician settings mode.....	8
P01 - Temperature set point.....	8
P02 - Lower limit temperature for heating .....	9
P03 -Time delay before stopping the heater.....	9
P04 - Manual mode ON time.....	10
P05 – Not in use.....	10
P06 - Enable/Disable 2 <sup>nd</sup> temperature sensor (Aquastat).....	10
P07 – Not in use.....	11
P08 – MODBUS MAC Address for building automation (option).....	11
P09 - Test conditions mode .....	12
Save changes and return to normal display.....	12
<b>Restore default values</b> .....	<b>12</b>
<b>DIP Switch settings</b> .....	<b>13</b>
DIP switch S2 - Short measuring times (test only) .....	13
DIP switches S3 and S4 – not in use.....	13
<b>Temperature reading errors</b> .....	<b>14</b>
MODBUS communication error.....	14
Temperature sensor not connected or short circuit .....	14
<b>Calibrating and testing the internal GFCI</b> .....	<b>14</b>
<b>MODBUS object list</b> .....	<b>15</b>

## Introduction

The FPC-02 Series power boxes offer smart and easy control for HEAT TRACING SYSTEMS.

It can operate one heating zones.

Typical applications include pipes, valves and gutters.

The backlit LCD screen provides full interface and information to the system status.

The FPC-02 offers various operating and programming options such as:

- Switchable temperature scales ( $^{\circ}\text{F}$  or  $^{\circ}\text{C}$ )
- Both Automatic and Manual modes
- Energy saving temperature limit
- Adjustable heater hold on off delay
- Adjustable Lower ambient temperature limit to stop heater (lockout)
- Commissioning/Test environment

### FPC-02 General system layout

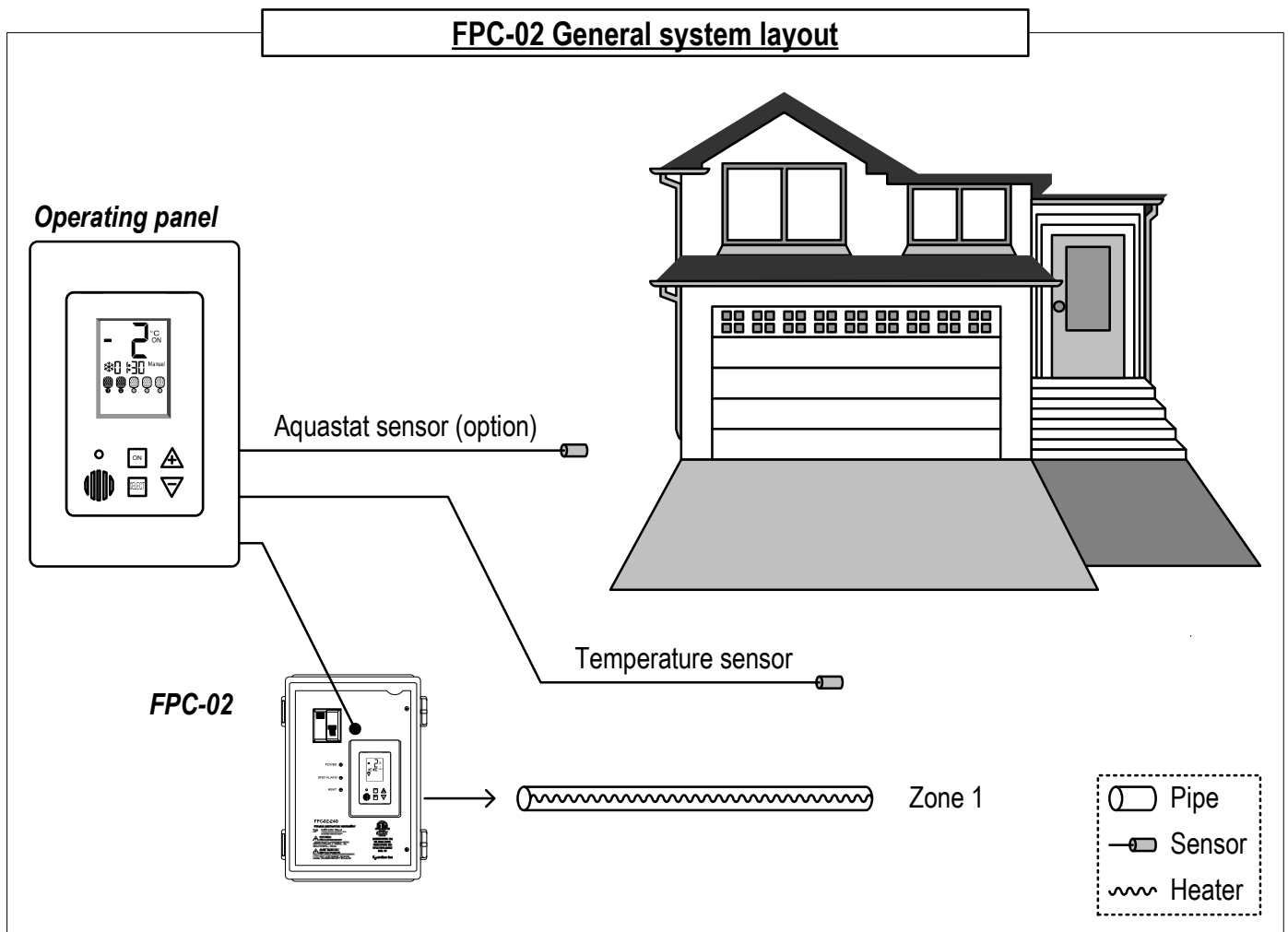

## FPC-02 Series

Owner's manual & Technician Settings

Pg. 3

Tel: (856) 2882882  
Tel: +972-3-9626462  
Fax: +972-3-9626620  
support@meitavtec.com

 meitav-tec

## FPC-02 Series Installation

**PLEASE READ THIS MANUAL AND THE SAFETY WARNINGS CAREFULLY BEFORE INSTALLING AND USING THE CONTROLLER AND SAVE IT FOR FUTURE USE**

### Installation notes

- Familiarize yourself with the markings, warnings, components and terminology.
- The FPC-02 power boxes and its accessories must be installed by a qualified electrician in accordance with local regulations and the requirements of the NEC (NFPA 72 ) and the CEC part 1.
- **WARNING:** Ensure the power is disconnect from all circuits before mounting the power box and making any connections. Contact with components carrying hazardous voltage can cause electric shock and may result in severe personal injury or death.
- **Installer must ensure the installation of approved disconnect means, for all power supply circuits feeding this unit.**
- The power boxes are suitable for indoor wall mount installation only.
- Ensure wiring according to the provided schematics using copper conductors only.
- Make sure the wire gauge (AWG) is suitable for the circuit amperage draw, as specified in the NEC/CEC table 1.
- Ensure that the main breakers (fuses) are suitable for the heating systems rating (80% load).
- Grounding means must comply with local regulations and CEC/NEC.
- Ensure that the heating system/de-icing system connected to this unit complies with the UL 499 or UL 515 & CSA 22.2 # 130.3 standard and is certified / listed by an NRTL.
- Ensure that all wiring is rated for the application at 60°C (140°F as per UL 515 CSA 22.2 #130 clause 12 table 12.1.
- Ensure that any holes punched for conduit are to compromise the integrity of the enclosure ratings.

### Ground fault equipment protection (GFEP)

- The ground fault interrupter/residual current detector installed in this system is a Non class A GFCI, intended for equipment protection.
- Familiar yourself with its operation and required setting.
- The GFEP should be tested monthly. Please refer to the calibration and testing instructions in appendix 1 of this manual.

# Wiring the FPC-02

## Heater load connection

Provide terminals L, N with up to 120 VAC, 30 AMP.

Make sure the wire Gauge (AWG) is suitable for the circuit Amperage draw, as specified in the NEC/CEC table 1.



**Caution: Incorrect voltage may cause fire or seriously damage the unit.**

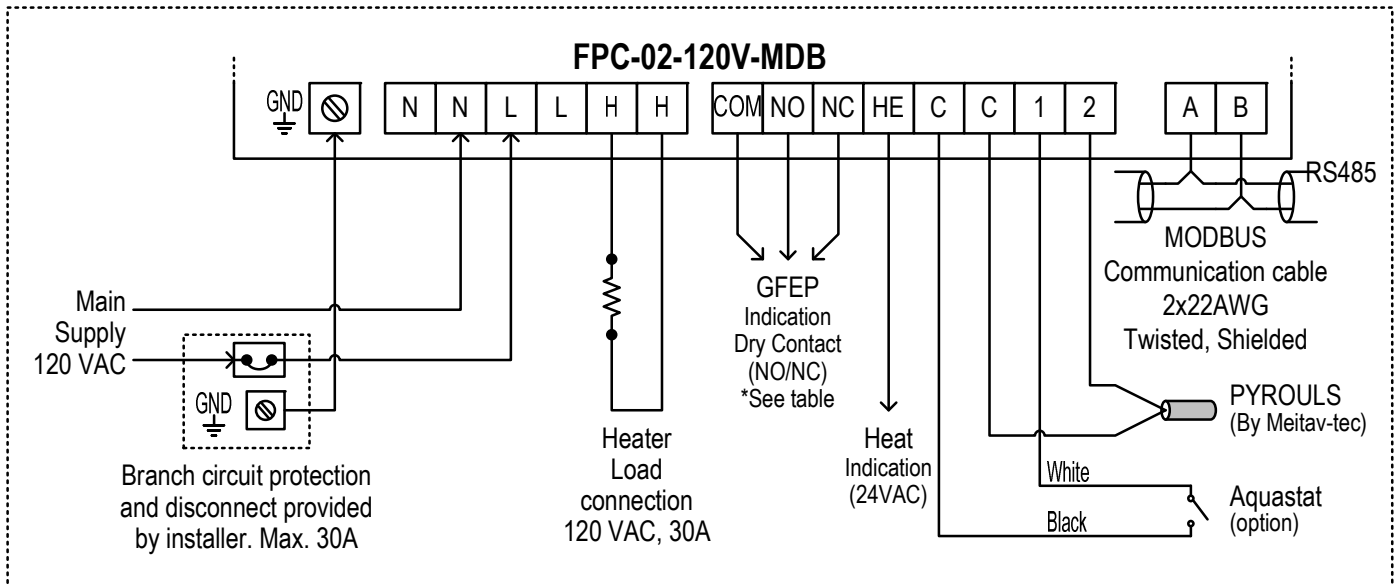
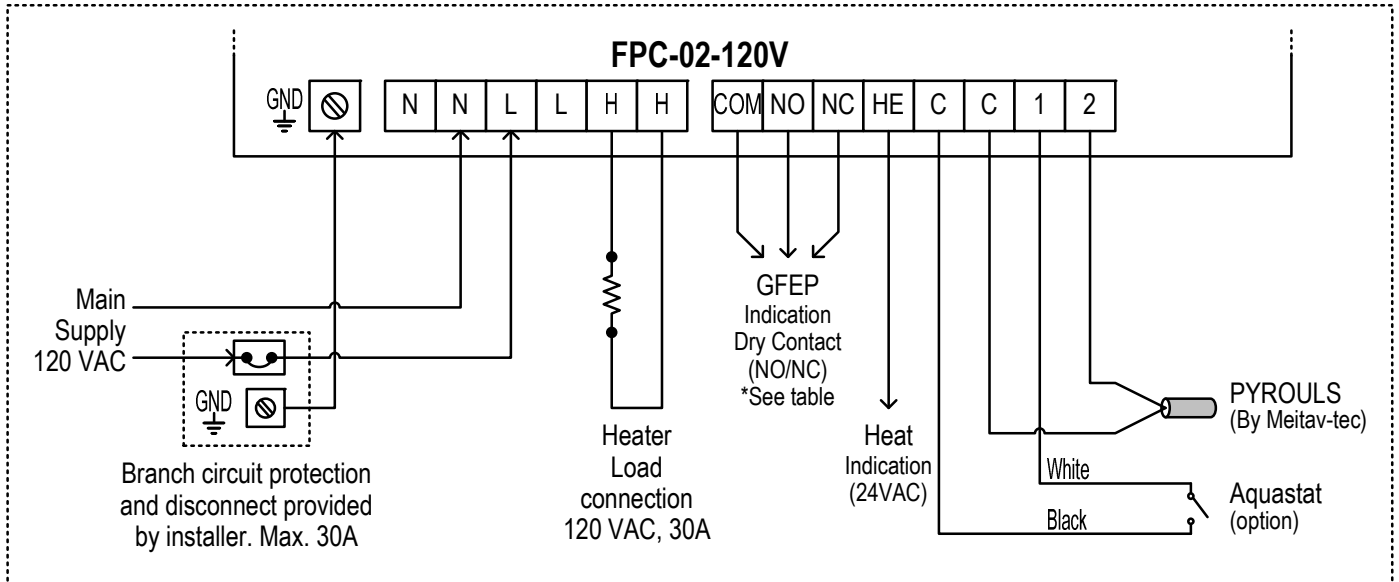

### \*GFEP Indication - Dry Contact

	NO - COM	NC - COM
GFEP Tripped	SHORT	OPEN
GFEP NOT Tripped	OPEN	SHORT

## FPC-02 Series

Owner's manual & Technician Settings

# Wiring the FPC-02

## Heater load connection

Provide terminals L, N with up to 240 VAC, 30 AMP.

Make sure the wire Gauge (AWG) is suitable for the circuit Amperage draw, as specified in the NEC/CEC table 1.



**Caution: Incorrect voltage may cause fire or seriously damage the unit.**

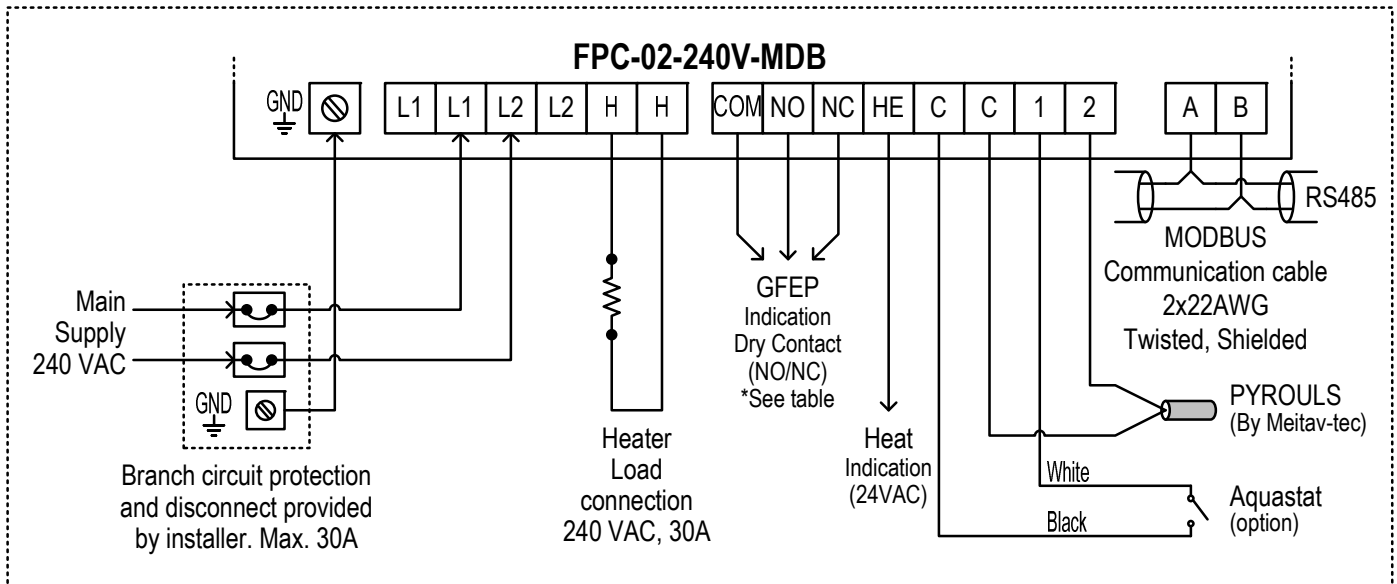
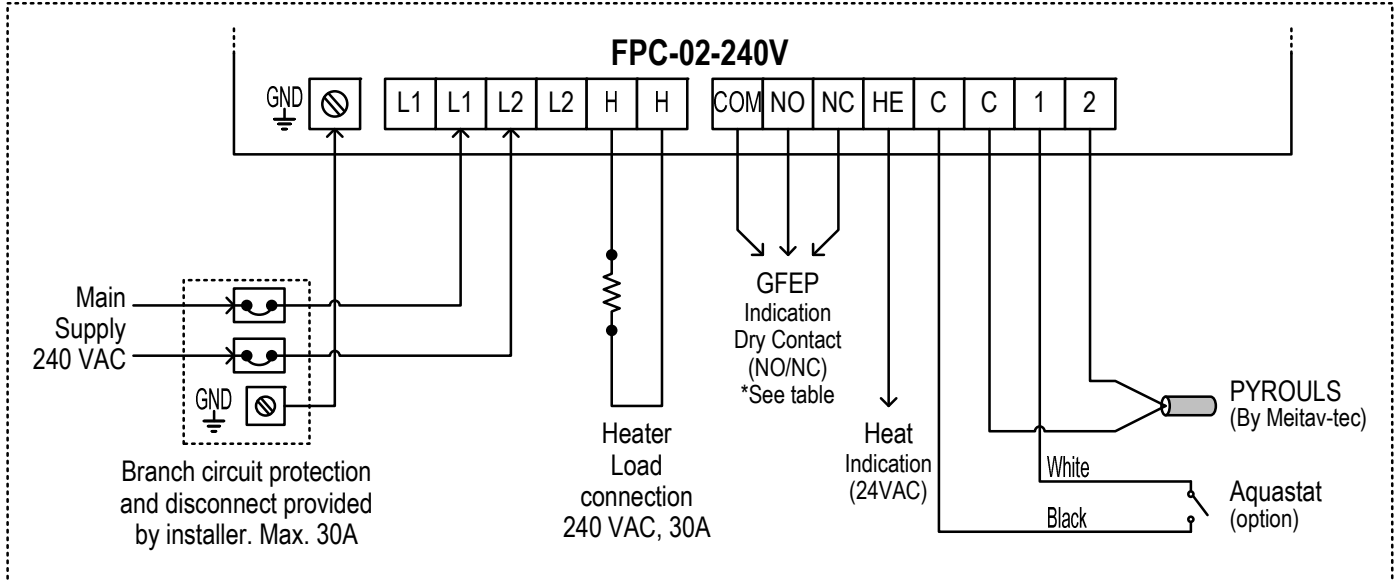

### \*GFEP Indication - Dry Contact

	NO - COM	NC - COM
GFEP Tripped	SHORT	OPEN
GFEP NOT Tripped	OPEN	SHORT

## Operating instructions

### Turning the system ON and OFF

- Press and hold the [ON] button for 0.5 seconds to turn the system ON or OFF.
- The words "ON" or "OFF" will appear on display.
- When ON, the green LED on the front panel will also turn ON.

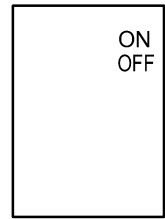

### Selecting temperature scale

- Press the [+] button for Celsius.
- Press the [-] button for Fahrenheit.

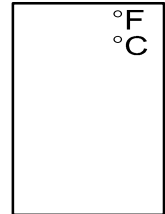

### Selecting Automatic or Manual mode

- Press the [SELECT] button to switch between modes:
  - “Automatic” Heating will start and stop automatically depending on the set point and ambient temperatures.
  - “Manual ON” Heating will start regardless of the set point and ambient temperatures and will stop after a preset time (pls. refer to the “Manual ON” section in the tech. settings).

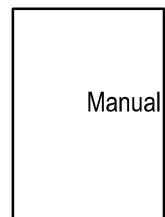
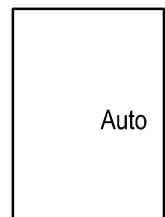

Note: Mode will always return to “Automatic” after switching the unit OFF and ON.

### Heater indication

Black icon – Heater ON

White icon – Heater OFF



Heater ON



Heater OFF

When ON, the red LED on the front panel indicating heater operation will also turn ON.

### Snow flake icon and digital time indication

A solid snow flake icon will appear on display during normal heater operation.



A blinking snow flake icon will appear on display during heater off delay or when manual mode is activated. The digital clock will count down the remaining time until the heater is turned off.

The snow flake icon will disappear from display as long as the heater is turned off.



## Technician settings

Use the technician settings mode to view and adjust the following parameters:

P01	Temperature set point	P06	Enable/Disable 2 <sup>nd</sup> temperature sensor logic (Aquatat)
P02	Lower ambient temperature limit to stop the heater	P07	Not in use
P03	Time delay before stopping the heater	P08	MODBUS MAC Address for home automation system (option)
P04	ON time for manual mode	P09	Commissioning / Test mode
P05	Not in use		Restore defaults

### Enter technician settings mode

- Disconnect power and open the internal door by releasing the two screws.
- Move DIP switch S1 located on the side of thermostat to ON position.
- Press the [SELECT] and [+] buttons simultaneously to move forward to the next technician parameter.
- Press the [SELECT] and [-] buttons simultaneously to return to the previous technician parameter.

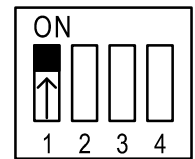

Enter technician settings mode

### Save changes and exit technician settings mode

- Move DIP switch S1 located on the side of thermostat to OFF position.

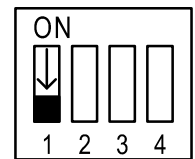

Save changes and exit technician settings mode

**Important: Changes made to technician parameters will not take effect as long as DIP switch S1 is in ON position.**

### Parameters:

#### P01 - Temperature set point

- Move DIP switch S1 located on the side of thermostat to ON position.
- "P01" and the temperature set point will appear on display.
- Use the [+] and [-] buttons to adjust the temperature set point.  
Range: 5...60°F / -15...+15°C, Default: 37°F / 3°C

As long as the ambient temperature is lower than the temperature set point P01, the FPC-02 will turn ON.

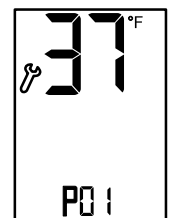

Temperature set point

## Technician settings (Cont')

### P02 - Lower limit temperature for heating

- Press the [SELECT] and [+] buttons simultaneously.
- "P02" and the low limit temperature will appear on display.  
When the temperature on the temperature sensor drops below the low temperature limit, the heating system will stop.
- Use the [+] and [-] buttons to adjust the temperature set point.  
Range: -40...+23°F / -40...-5°C    Default: -40°F / -40°C
- Press the [SELECT] and [+] buttons simultaneously again.
- The word "ON" or "OFF" will appear on display.
- Use the [+] and [-] buttons enable (ON) or disable (OFF) the P02 parameter.  
If disabled, the heating system will operate without low temperature limitations.

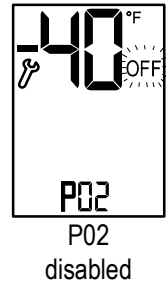
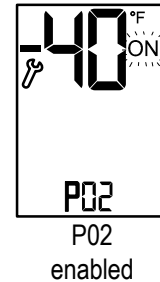
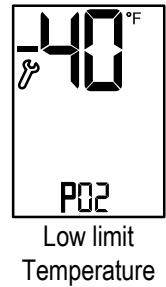

### P03 -Time delay before stopping the heater

- Press the [SELECT] and [+] buttons simultaneously.
- "P03", "dL" and the time delay before stopping the heater (Hold ON) will appear on display. The hours will blink.
- Use the [+] and [-] buttons to adjust the hours of the time delay.  
Range: 0000...9999 minutes    Default: 120 minutes

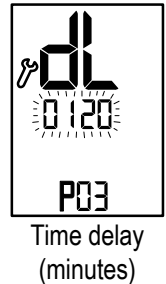

Note 1. The time delay countdown will start when the ambient temperatures rises above the set point temperature.

Note 2. The staggering sequence will continue during the time delay period.

↳ Cont'

## Technician settings (Cont')

### P04 - Manual mode ON time

- Press the [SELECT] and [+] buttons simultaneously.
- "P04", "On" and the time "Manual ON" mode time period will appear on display. The hours will blink.

The delay time parameter defines a time frame in which the heater remains ON after receiving an "Manual ON" command.

- Use the [+] and [-] buttons to adjust the hours of the working time.

Range: 00...99 hours                      Default: 03 hours

- Press the [SELECT] and [+] buttons simultaneously again.

- The minutes will blink.

- Use the [+] and [-] buttons to adjust the minutes of the working time.

Range: 00...59 minutes                      Default: 00 minutes

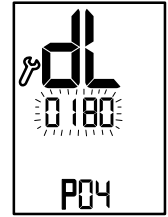

Manual ON  
(minutes)

### P05 – Not in use

- Press the [SELECT] and [+] buttons simultaneously.
- "P05" will appear on display.
- Proceed to P06.

### P06 – Enable/Disable Temperature sensor / Aquastat logic

- Press the [SELECT] and [+] buttons simultaneously.
- "P06" and the number "0" or "1" will appear on display.
- Use the [+] and [-] buttons to select between:

"0" - Logic set by both TEMPERATURE SENSOR and AQUASTAT (default).

"1" - Logic set by TEMPERATURE sensor only.

"2" - Logic set by AQUASTAT sensor only

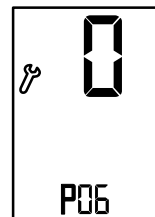

Logic by  
temperature  
sensor and  
aquastat

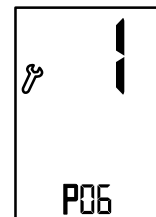

Logic by  
temperature  
sensor only

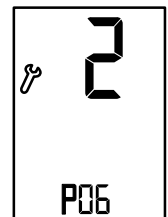

Logic by aquastat  
sensor only

↳ Cont'

## Technician settings (Cont')

---

### P07 – Not in use

---

- Press the [SELECT] and [+] buttons simultaneously.
- “P07” will appear on display.
- Proceed to P08.

### P08 – MODBUS MAC Address (for MDB models only)

---

- Press the [SELECT] and [+] buttons simultaneously.
- “P08” and the MODBUS MAC Address will appear on display.
- Use the [+] and [-] buttons to set the MAC Address of the unit.

Setting the MAC address for the unit will make it available through the home automation system.

Range: 0 – 60.

Select “0” for NO COMMUNICATION system (default).

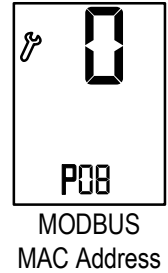

↳ Cont'

## Technician settings (Cont')

### P09 - Test conditions mode / Technician commissioning mode

Turn ON test conditions to check the functionality of the system regardless of temperature sensors parameters (i.e. during the summer).

In test conditions, the Ambient temperature is always  $-7^{\circ}\text{C}/19^{\circ}\text{F}$ .

- Press the [SELECT] and [+] buttons simultaneously.
- "P09" will appear on display. The hours will blink.
- Use the [+] button to enter test/commissioning mode – the word "Test" will appear on display.
- Use the [-] button to manually exit test/commissioning mode – the word "Test" will disappear from display.

Note: If the technician did not manually exit test/commissioning mode, the unit will automatically return to normal mode after 5 hours.

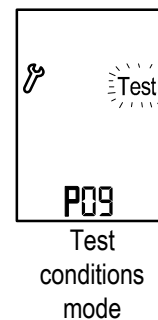

### Save changes and return to normal display

- In order to save changes and return to normal display, move DIP switch S1 back to OFF position.

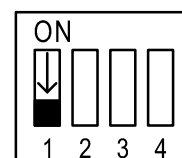

**Important: Changes made to technician parameters will not take effect as long as DIP switch S1 is in ON position.**

### Restore default values

- Move DIP switch S1 to ON position.
- Press and hold the [ON] button for 10 seconds. The controller will beep.
- Move DIP switch S1 back to OFF position.

## Technician settings (Cont')

---

### DIP switch S2 - Short measuring times (test only)

---

- Use DIP switch S2 to short the
  - "ON" - Short measuring times – for test/commissioning only (measuring times will be divided by 60).
  - "OFF" - Normal operation.

Short measuring times: A real 1 hour will take 1 minute and a real 1 minute will take 1 second.

### DIP switches S3 and S4 – Not in use (must be in OFF position)

---



S3 OFF, S4 OFF

## System Errors

---

### Error 1 – MODBUS Communication error

“Aux1” Will appear on display.

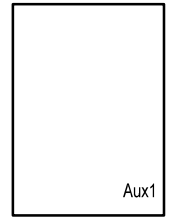

Communication error

---

### Error 2 – Temperature sensor is not connected or short circuit

“SensErr 1” Will appear on display.

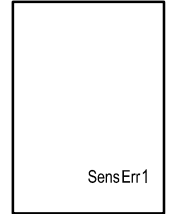

Temperature Sensor error

---

## GFEP

The GFEP is designed to provide protection for electrical equipment.

### GFEP TEST

The GFEP should be tested monthly. Press the blue “T” test button to trip the outlet and break the circuit. The YELLOW LED on the front panel should lit. Lift the RESET GFEP button to return to normal operation and reestablish power and protection.

Test button.....

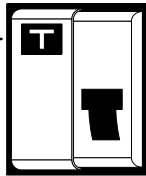

.....Reset button

## Object list (for MDB models only)

OBJECT LIST FOR FPC-02-MDB Series rev. 1.0

MODBUS RTU Mode, Address Slave 1-60, Baud Rate 9600, n, 8, 1

All Registers Signed Integer 16 bit,

R - Register Read Only, R/W - Register Read/Write

Dec,[Hex]	Value	Description	Read/Write
0, [0000]	-13°F .. 54°F / -40..+16°C	Measured Temperature	R
1, [0001]	5°F... 59°F /-15°C...+15°C	P01 – Temperature set point	R/W
2, [0002]	-40°F... +23°F/-40°C...-5°C	P02 – Lower temperature limit for heating	R/W
3, [0003]	min (0-9999)	P03 – Time delay before stopping the heater	R/W
4, [0004]	min (0-9999)	P04 – Manual mode ON time	R/W
5, [0005]	60	P05 – Not in use	R
6, [0006]	0,1,2	P06 – Enable/Disable temp. sensor/Aquastat logic	R/W
7, [0007]		P07 – Not in use	R/W
8, [0008]	0/1	P09 – Test conditions mode	R/W
9, [0009]	0/1/2	Heater 1 (0-OFF, 1-ON, 2-Not in use)	R/W
10, [000A]	0/1/2	Not in use	R/W
11, [000B]	0/1/2	Not in use	R/W
12, [000C]	0/1/2	Not in use	R/W
13, [000D]	0/1/2	Not in use	R/W
14, [000E]	0/1	Aquastat Signal (0-OFF, 1-ON)	R
15, [000F]	0/1	SW1	R
16, [0010]	0/1	SW2	R
17, [0011]	0/1	SW3 – Not in use	R
18, [0012]	0/1	SW4 – Not in use	R
19, [0013]	0/1	ON/OFF (0-OFF, 1-ON)	R/W
20, [0014]	0/1	Celsius/Fahrenheit (0-F, 1-C)	R/W





**Tel: (856) 2882882**

**Tel: +972-3-9626462**

**Fax: +972-3-9626620**

**support@meitavtec.com**

**www.meitavtec.com**