



Touch Screen Wall Panel

**MTSC/SUPER**

Owner's manual and technician settings

 **meitav-tec**



## Index

---

<b>1. Owner's Manual .....</b>	<b>4</b>
1.1 Quick Guide.....	4
1.2 Turning the unit ON or OFF.....	5
1.3 Adjusting the set-point temperature .....	5
1.4 Switch between temperature scales .....	5
1.5 Switching between System modes.....	6
1.6 Switching between Fan speeds .....	6
1.7 Fan on demand (Auto fan).....	7
1.8 Lock the thermostat's buttons.....	7
1.9 Timer for turning the thermostat off.....	7
<b>2. Installation Instructions.....</b>	<b>8</b>
<b>3. Wiring Configuration and DIP Switches.....</b>	<b>11</b>
<b>4. Technician Settings .....</b>	<b>18</b>
<b>5. MAC Address .....</b>	<b>34</b>

# 1. Owner's manual

## 1.1 Quick Guide

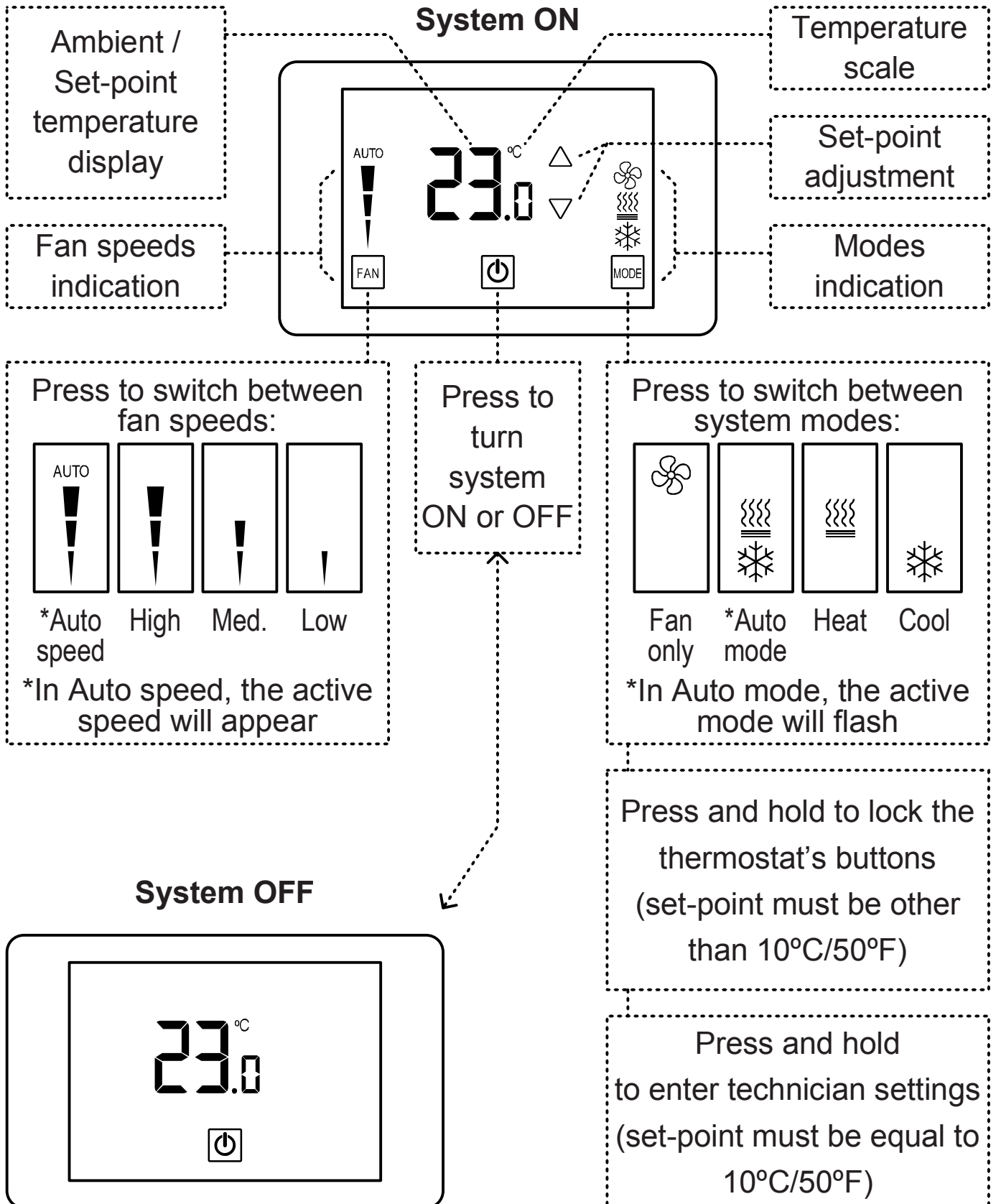

## 1.2 Turning the unit ON or OFF

---

- Press the  button to turn the unit ON – system mode and fan speed symbols will appear on display.
- Press again to turn the unit OFF – the symbols will disappear.

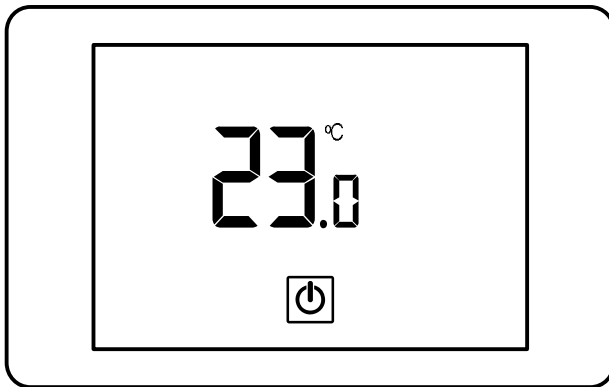

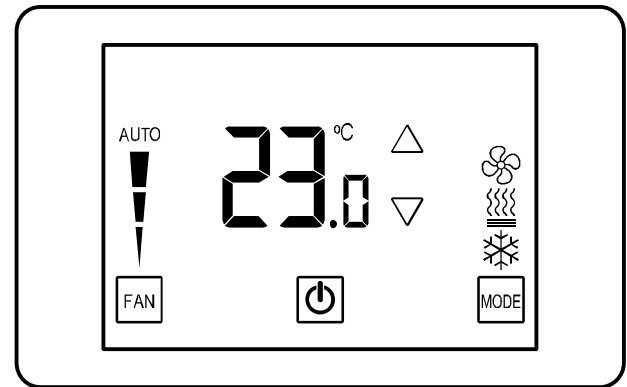

Unit OFF



Unit ON

## 1.3 Adjusting the set-point temperature

---

- While the thermostat is ON, press the  or  buttons – the set-point temperature will flash.
- Press again to adjust the set point.

## 1.4 Switching between temperature scales

---

- Press and hold the  button to switch between temperature scales.



Note: set-point must be other than 10°C, 11°C/50°F, 51°F

## 1.5 Switching between system modes

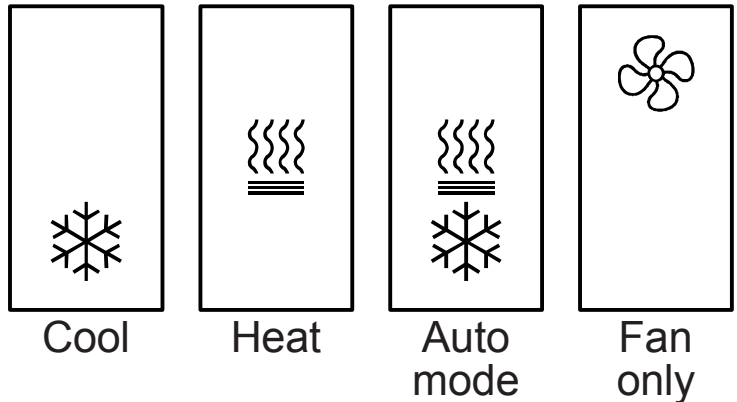
- Press the  button to switch between system modes:



Notes:

- During demand for cooling (cooling active), the  will flash.
- During demand for heating (heating active), the  will flash.

The selection of system modes may be disabled depending on system configuration.

## 1.6 Switching between fan speeds

- Press the  button to switch between fan speeds:

Note: When Auto speed is selected, the word "AUTO" and the active fan speed will appear on display

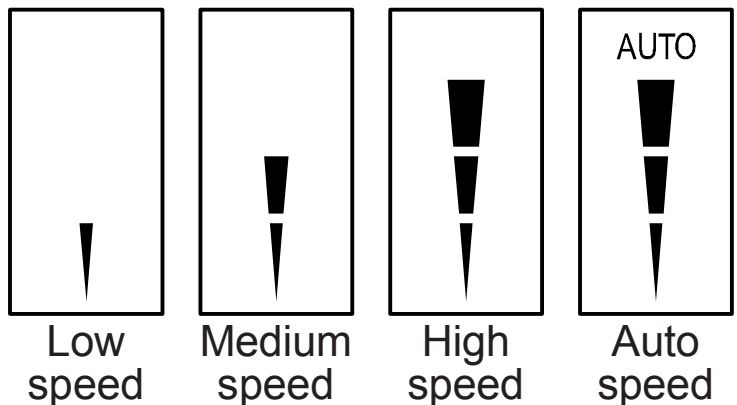

The selection of fan speeds may be disabled depending on system configuration.

## 1.7 Fan on demand (Auto fan)

---

- Press and hold the  button to activate or deactivate fan on demand (Auto fan) function.

Notes:



- When activated, the fan will run with demand for cooling or heating.
- The fan on demand function cannot be activated with “Fan only” mode.



This option may be disabled, depending on system configuration.



## 1.8 Lock the thermostat's buttons

---

- Press and hold the  button to lock or unlock the thermostat's buttons. When locked, the  icon will appear on display.

## 1.9 Timer for turning the thermostat off

---

- Press and hold the  button – the hours for the off-timer will appear on display. Adjust the timer using the  and  buttons.

Range: 0...10 Hours

Note: Set “0” to disable the timer.

## 2. Installation Instructions

---

The MTC/SUPER Thermostat designed for flush mounting in the room to be controlled. It should be located where the occupant can easily read the display and use the controls.

If the built in temperature sensor is being used to measure room temperature, the panel should be placed where the temperature is representative of the general room conditions, away from cold or warm air draughts, radiant heat and direct sunlight.

The panel should not be installed on an outside wall.

- The standard installation height is 1.5 meter (5 feet) from the floor.



**WARNING:** Risk of Electric Shock and Property Damage.  
Disconnect power supply before making electrical connections.  
The installation is to be performed by a qualified electrician.



**WARNING:** The integrated circuits in the controller are sensitive to static currents. Take suitable precautions.



## 2. Installation Instructions (cont')

---

Installation procedure:

1. separate the front display from the back plastic cover by inserting a small flat screwdriver into each of the three slots as shown in the picture and rotating it gently.
2. Remove the front display and keep it in a safe place.
3. Connect the wires as shown in the enclosed wiring diagram. All terminals accept 1x0.5mm<sup>2</sup>/24 AWG.
4. If necessary, make changes to the DIP switches position as explained in this manual.
5. Place the thermostat in the electrical box and tighten up the 2 screws (Gewiss Box - GW 24 203).
6. Adapt the front frame-panel into its place, by pushing it towards the wall.

## 2. Installation Instructions (cont')

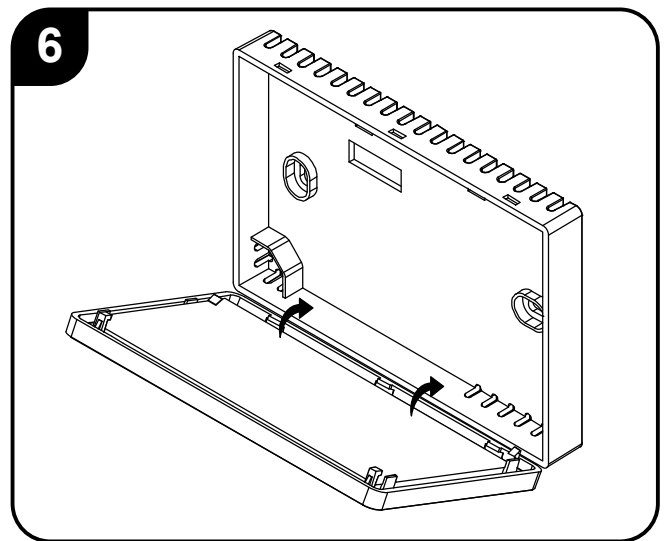
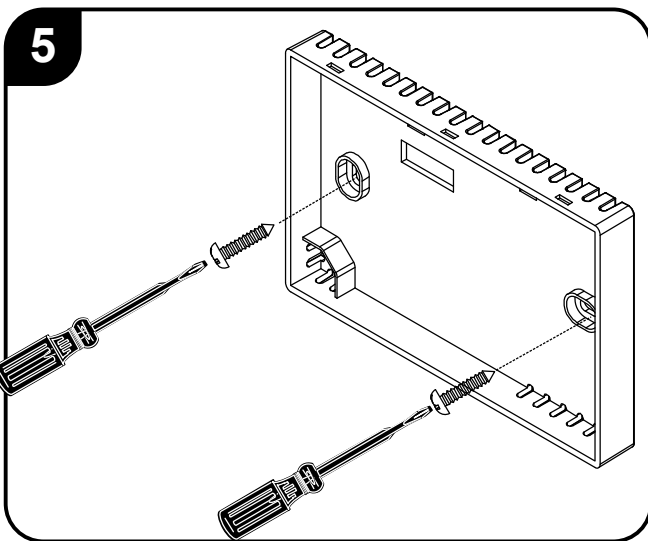
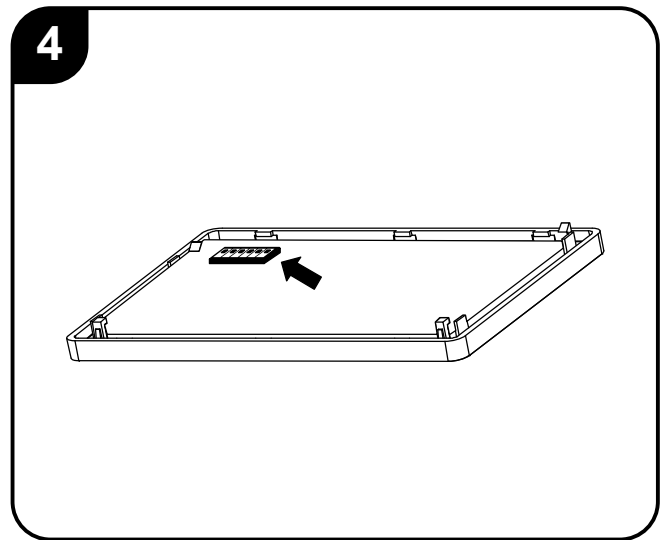
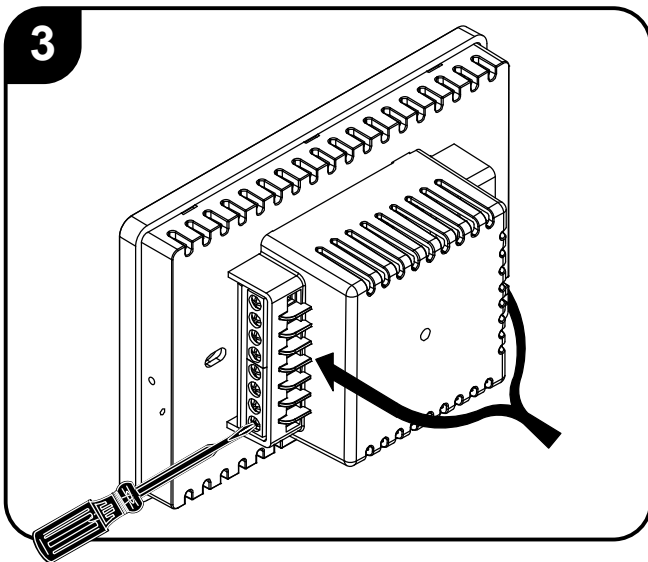
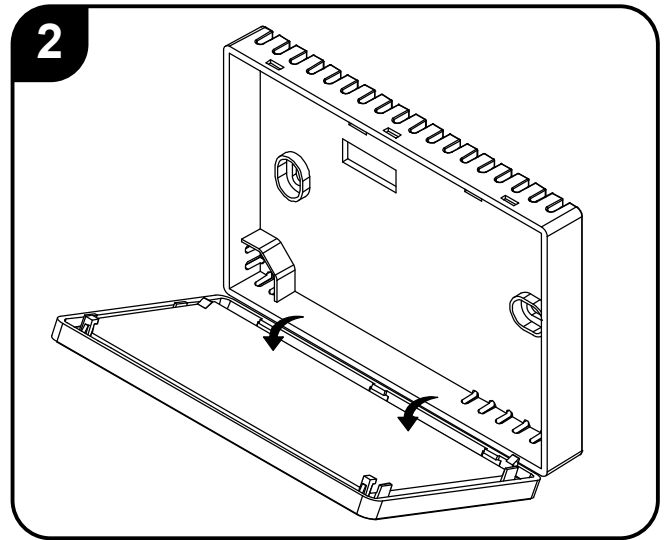
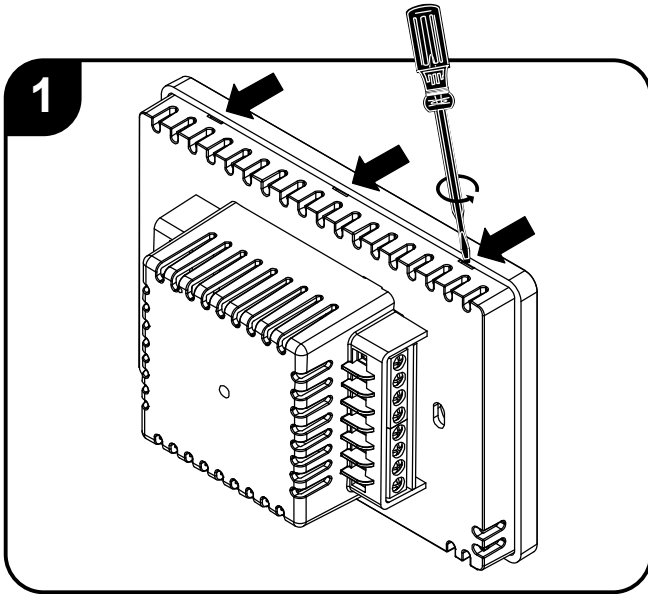

### 3. Wiring configuration and DIP Switches

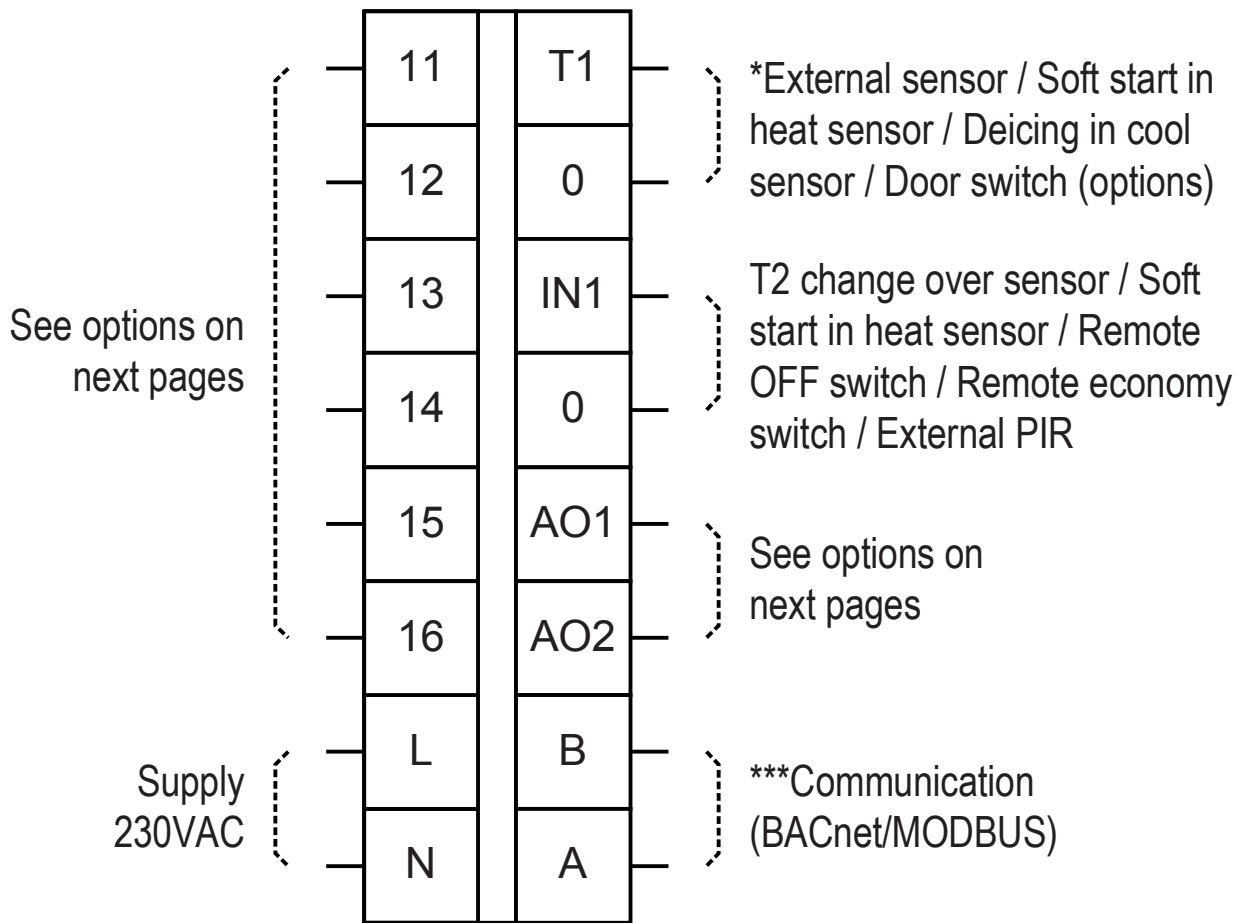

\* For T1,0 functionality – refer to parameter P8 in the technician settings section.

\*\* For IN1,0 functionality – refer to parameter P9 in the technician settings section.

\*\*\*Communication protocol is set by DIP Switch S1.8 as follows:

S1.8 ON – BACnet

S1.8 OFF – MODBUS

### 3. Wiring configuration and DIP Switches – AC systems

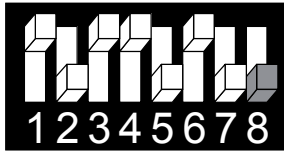
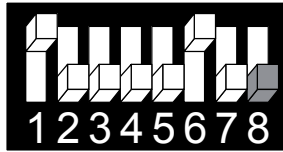
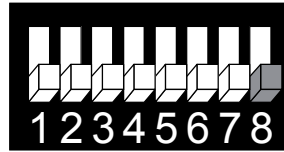
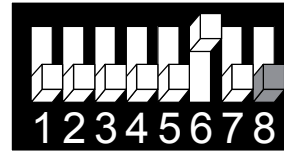
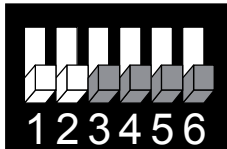
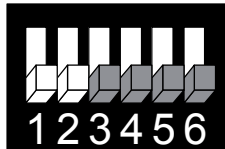
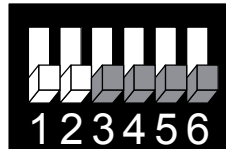
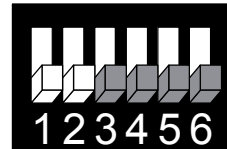
	<b>HC32-1S</b>	<b>HP42-1S</b>	<b>HP22-3S</b>	<b>HP21-3S</b>
11	Heat element 3	Heat element 2	Fan high	Fan high
12	Heat element 2	Heat element 1	Fan medium	Fan medium
13	Fan (1 speed)	Fan (1 speed)	Fan low	Fan low
14	Compressor 2	Compressor 2	Compressor 2	Heat element
15	Compressor 1	Compressor 1	Compressor 1	Compressor 1
16	Heat element 1 (see SW1.4 HC)	Heat pump (see SW1.4 HP)	Heat pump (see SW1.4 HP)	Heat pump (see SW1.4 HP)
AO1	X	X	X	X
AO2	X	X	X	X
<b>SW1</b>				
<b>SW2</b>				

SW1.8 = Protocol: ON – BACnet, OFF – MODBUS

SW1.4 = HP: ON – Heat pump active in cool, OFF – Heat pump active in heat  
 HC: ON – Electrical heater, OFF – Oil/Gas heater (no fan)

SW1.5 = ON: Disable compressor delay, OFF – Enable compressor delay

S2.3 – S2.6 – Not in use

HP - Heat pump system    HC - Non heat pump system    ## - Heating/Cooling stages

### 3. Wiring configuration and DIP Switches – AC systems

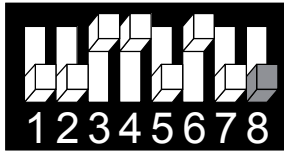
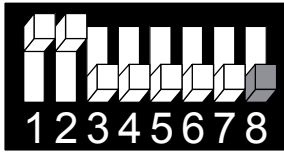
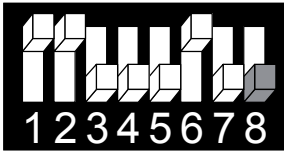
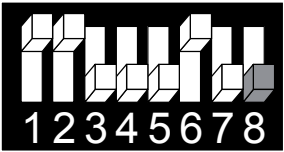
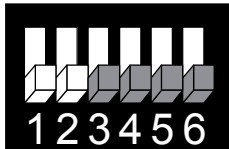
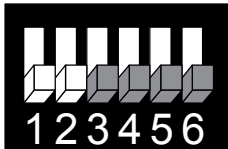
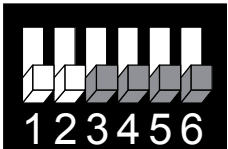
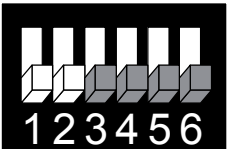
	<b>HC21-3S</b>	<b>HP22-VFS</b>	<b>HP21-VFS</b>	<b>HC21-VFS</b>
11	Fan high	Fan high	Fan high	Fan high
12	Fan medium	Fan medium	Fan medium	Fan medium
13	Fan low	Fan low	Fan low	Fan low
14	Heat element 2	Compressor 2	Heat element	Heat element 2
15	Compressor 1	Compressor 1	Compressor	Compressor 1
16	Heat element 1 (see SW1.4 HC)	Heat pump (see SW1.4 HP)	Heat pump (see SW1.4 HP)	Heat element 1 (see SW1.4 HC)
AO1	X	X	X	X
AO2	X	Fan VFS	Fan VFS	Fan VFS
<b>SW1</b>				
<b>SW2</b>				

SW1.8 = Protocol: ON – BACnet, OFF – MODBUS

SW1.4 = HP: ON – Heat pump active in cool, OFF – Heat pump active in heat  
 HC: ON – Electrical heater, OFF – Oil/Gas heater (no fan)

SW1.5 = ON: Disable compressor delay, OFF – Enable compressor delay

S2.3 – S2.6 – Not in use

HP - Heat pump system    HC - Non heat pump system    ## - Heating/Cooling stages  
 VFS - Fan VFS

### 3. Wiring configuration and DIP Switches – Fan coil systems

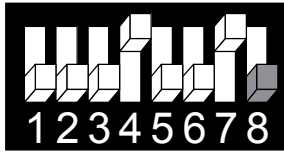
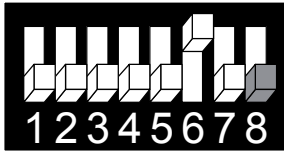
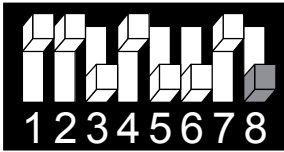
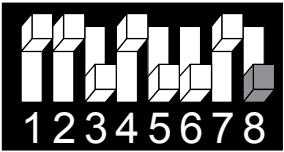
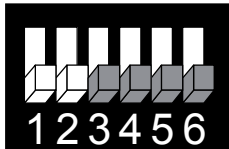
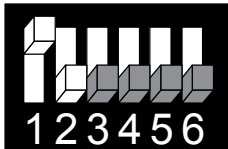
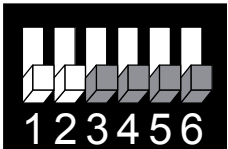
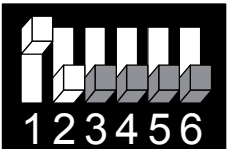
	2-Pipe 3S	2-Pipe PID 3S	2-Pipe VFS	2-Pipe PID VFS
11	Fan high	Fan high	Fan high	Fan high
12	Fan medium	Fan medium	Fan medium	Fan medium
13	Fan low	Fan low	Fan low	Fan low
14	Heat element (2 <sup>nd</sup> stage heat)	Heat element (2 <sup>nd</sup> stage heat)	Heat element (2 <sup>nd</sup> stage heat)	Heat element (2 <sup>nd</sup> stage heat)
15	Cool/Heat valve	X	Cool/Heat valve	X
16	X	X	X	X
AO1	X	Cl/Ht valve PID	X	Cl/Ht valve PID
AO2	X	X	Fan VFS	Fan VFS
SW1				
SW2				

SW1.8 = Communication Protocol: ON – BACnet, OFF – MODBUS

SW1.4 = Enable/Disable 2<sup>nd</sup> heating stage: ON – Enable, OFF – Disable

SW1.5 = Chilled beam option (fan will not run with 1<sup>st</sup> stage cooling) – SW1.5 ON

S2.3 – S2.6 – Not in use

PID = Cool/Heat (Cl/Ht) valve PID

VFS = Fan VFS

### 3. Wiring configuration and DIP Switches – Fan coil systems

	4-Pipe 3S	4-Pipe VFS	4-Pipe 3S C-PID
11	Fan high	Fan high	Fan high
12	Fan medium	Fan medium	Fan medium
13	Fan low	Fan low	Fan low
14	Heat element (2 <sup>nd</sup> stage heat)	Heat element (2 <sup>nd</sup> stage heat)	Heat element (2 <sup>nd</sup> stage heat)
15	Cool valve	Cool valve	X
16	Heat valve (1 <sup>st</sup> stage heat)	Heat valve (1 <sup>st</sup> stage heat)	Heat valve (1 <sup>st</sup> stage heat)
AO1	X	X	Cool valve PID
AO2	X	Fan VFS	X

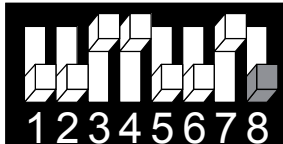
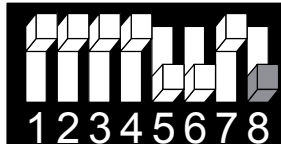
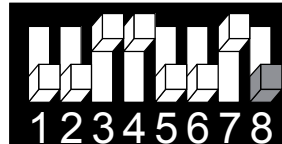
SW1			
-----	---	---	--

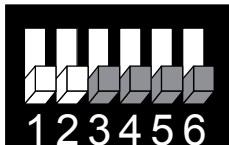
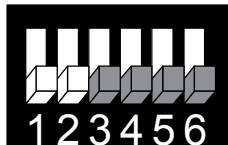
SW2			
-----	---	---	--

SW1.8 = Communication Protocol: ON – BACnet, OFF – MODBUS

SW1.4 = Enable/Disable 2<sup>nd</sup> heating stage: ON – Enable, OFF – Disable

SW1.5 = Chilled beam option (fan will not run with 1<sup>st</sup> stage cooling) – SW1.5 ON

S2.3 – S2.6 – Not in use

C-PID = Cool valve PID

H-PID = Heat valve PID

VFS = Fan VFS

### 3. Wiring configuration and DIP Switches – Fan coil systems

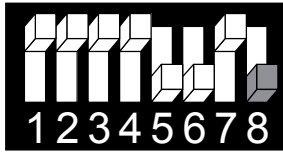
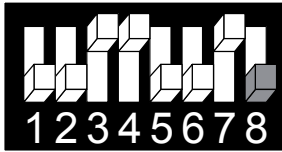
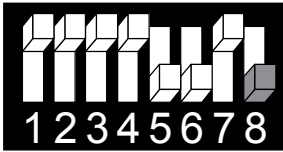
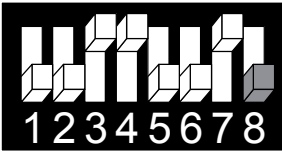
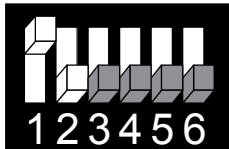
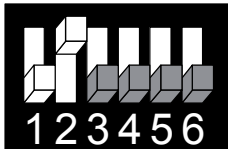
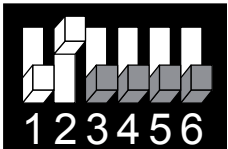
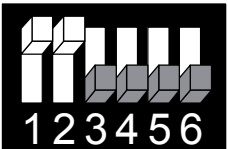
	4-Pipe VFS C-PID	4-Pipe 3S H-PID	4-Pipe VFS H-PID	4-Pipe 3S HC-PID
11	Fan high	Fan high	Fan high	Fan high
12	Fan medium	Fan medium	Fan medium	Fan medium
13	Fan low	Fan low	Fan low	Fan low
14	Heat element (2 <sup>nd</sup> stage heat)	Heat element (2 <sup>nd</sup> stage heat)	Heat element (2 <sup>nd</sup> stage heat)	Heat element (2 <sup>nd</sup> stage heat)
15	X	Cool valve	Cool valve	X
16	Heat valve (1 <sup>st</sup> stage heat)	X	X	X
AO1	Cool valve PID	Heat valve PID (1 <sup>st</sup> stage heat)	Heat valve PID (1 <sup>st</sup> stage heat)	Cool valve PID
AO2	Fan VFS	X	Fan VFS	Heat valve PID (1 <sup>st</sup> stage heat)
SW1				
SW2				

SW1.8 = Protocol: ON – BACnet, OFF – MODBUS

SW1.4 = Enable/Disable 2<sup>nd</sup> heating stage: ON – Enable, OFF – Disable

SW1.5 = Chilled beam option (fan will not run with 1<sup>st</sup> stage cooling) – SW1.5 ON

S2.3 – S2.6 – Not in use

C-PID = Cool valve PID

H-PID = Heat valve PID

HC-PID = Cool and Heat valves PID

VFS = Fan VFS



### 3. Wiring configuration and DIP Switches – Fan coil systems

	<b>4P-3S Floor heating</b>	<b>4-Pipe 3S C-PID Floor heating</b>	<b>4-Pipe VFS C-PID Floor heating</b>
11	Fan high	Fan high	Fan high
12	Fan medium	Fan medium	Fan medium
13	Fan low	Fan low	Fan low
14	Floor heating (1 <sup>st</sup> stage heat)	Floor heating (1 <sup>st</sup> stage heat)	Floor heating (1 <sup>st</sup> stage heat)
15	Cool	X	X
16	Heat (2 <sup>nd</sup> stage heat)	Heat (2 <sup>nd</sup> stage heat)	Heat (2 <sup>nd</sup> stage heat)
AO1	X	Cool valve PID	Cool valve PID
AO2	X	X	Fan VFS

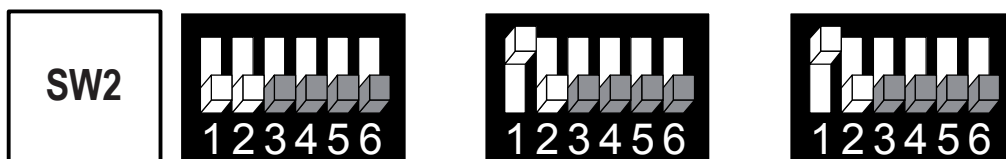

Floor heating – the fan will not run with 1<sup>st</sup> stage heat

SW1.8 = Protocol: ON – BACnet, OFF – MODBUS

SW1.4 = Enable/Disable 2<sup>nd</sup> heating stage: ON – Enable, OFF – Disable

SW1.5 = Chilled beam option (fan will not run with 1<sup>st</sup> stage cooling) – SW1.5 ON

S2.3 – S2.6 – Not in use

C-PID = Cool valve PID

H-PID = Heat valve PID





HC-PID = Cool and Heat valves PID

VFS = Fan VFS

## 4. Technician Settings

---

### Enter technician settings

- Adjust the set-point temperature to 10°C.
- To enter technician settings, press and hold the  button for 5 seconds.
- Use the  button to advance to the next parameter.
- Use the  button to return to return to the previous parameter.
- Press the  button or wait 60 seconds to exit technician settings and return to normal display.

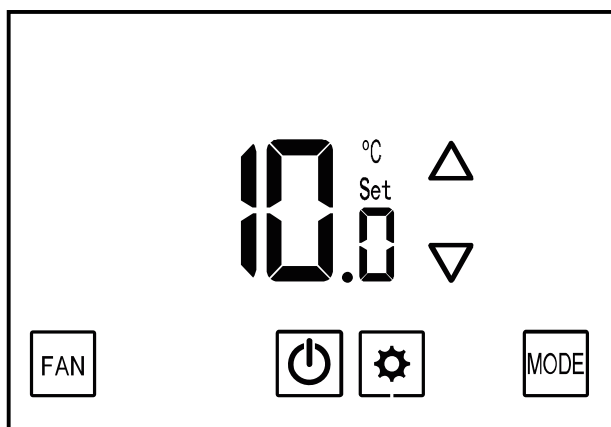

(Press and hold)

## 4. Technician settings (cont')

---

### **P1 – Offset for temperature readings calibration**

Range: -6...+6°C / -9...+9°F.

Default: 0°C / 0°F.

---

### **P2 – Set point limit for cooling**

Range: 5...35°C / 41...90°F.

Default: 5°C / 35°F.

---

### **P3 – Set point limit for heating**

Range: 5...35°C / 41...95°F.

Default: 35°C / 95°F.

---

### **P4 – Lock the [Fan] button**

“01” - [Fan] button Locked

“00” - [Fan] button unlocked

---

### **P5 – Lock the [Mode] button**

“01” - [Mode] button Locked

“00” - [Mode] button unlocked (default)

---

### **P6 – Lock the [On/Off] button**

“01” - [On/Off] button Locked

“00” - [On/Off] button unlocked (default)

---

## 4. Technician settings (cont')

---

### **P7 – Lock the [+] and [-] buttons (Set buttons)**

- “01” - [+] and [-] buttons Locked
  - “00” - [+] and [-] buttons unlocked (default)
- 

### **P8 – Functionality of T1 terminals**

- “00” - T1 terminals are not in use (default)
  - “01” - External sensor
  - “02” - Soft start in heat sensor (FC), Deicing in cool (AC)
  - “03” - Door switch
- 

### **P9 – Functionality of In1,0 terminals**

- “00” - In1,0 terminals are not in use (default)
- “01” - T2 (Change over sensor)
- “02” - \*T3 (Soft start in heat sensor)
- “03” - Remote On/Off switch
- “04” - Remote Economy switch
- “05” - External Passive Infrared detector (PIR)

\* Where T1 terminals are used for external sensor, the In1,0 terminals can be used for T3 sensor.

---

### **P10 – Window contact (terminals In1,0) polarity**

- “00” - Normally open (default)
  - “01” - Normally close
-

## 4. Technician settings (cont')

---

### **P11 – Window contact delay time**

Range: 0...999 seconds

Default: 600 seconds

---

### **P12 – Door switch / Door key-tag (terminals T1,0) polarity**

“00” - Normally open (default)

“01” - Normally close

---

### **P13 – Door switch / Door key-tag delay time**

Range: 0...999 seconds

Default: 180 seconds

---

### **P14 – Enable/Disable Auto change over mode**

“00” - Disable Auto change over mode

“01” - Enable Auto change over mode (default)

---

### **P15 – Occupancy sensor logic (PIR)**

“00” - Thermostat turns off when unoccupied  
and back on when re-occupied

“01” - Thermostat turns off when unoccupied  
and remains off when re-occupied

“02” - Thermostat uses economy set points (default)

---

### **P16 – Enable/Disable Occupancy sensor**

“00” - Disable

“01” - Enable (default)

---

## 4. Technician settings (cont')

---

**P17 – PIR (occupancy sensor) delay time before switching to unoccupied mode (ON delay)**

Range: 0...250 minutes, Default: 20 minutes

---

**P19 – PIR (Occupancy sensor) polarity**

“00” - Normally open (default)

“01” - Normally close

---

**P25 – Economy set point for cooling**

Range: 5...35°C / 41...90°F

Default: 30°C / 86°F

---

**P26 – Economy set point for heating**

Range: 5...35°C / 41...90°F

Default: 10°C / 50°F

---

## 4. Technician settings (cont')

---

### **P27 – Time on-delay between heating stages**

Range: 0...600 seconds

Default: 5 seconds

---

### **P28 – Time off-delay between heating stages**

Range: 0...600 seconds

Default: 1 seconds

---

### **P30 – Beeper ON or OFF**

“01” - Beeper ON (default)

“00” - Beeper OFF

---

### **P31 – Fan ON delay in cooling (seconds)**

Range: 0...120 seconds

Default: 0 seconds (no delay)

---

### **P32 – Fan OFF delay in cooling (seconds)**

Range: 0...120 seconds

Default: 0 seconds (no delay)

---

### **P33 – Fan ON delay in heating (seconds)**

Range: 0...120 seconds

Default: 0 seconds (no delay)

---

### **P34 – Fan OFF delay in heating (seconds)**

Range: 0...120 seconds

Default: 30 seconds

---

## 4. Technician settings (cont')

---

### **P35 – Enable/Disable Freeze protection**

“01” - Enable freeze protection (default)

“00” - Disable freeze protection

---

### **P36 – Freeze protection cut-in set point**

Range: 8...15°C / 46...59°F

Default: 8°C / 46°F

---

### **P37 – Freeze protection cut-out set point**

Range: 10...17°C / 50...63°F

Default: 10°C / 50°F

---

### **P40 – View filter counter (hours) – Read only**

Range: 0...999 hours

---

### **P41 – Reset filter time**

“00” - No action - keep counting (default)

“01” - Reset filter counter

---

### **P42 – Adjust filter alarm delay time counter (hours)**

Range: 0...999 hours

Default: 0 hours (0 = Disable)

---



## 4. Technician settings (cont')

---

### **P43 – Soft start in heat – cut-in temperature**

The fan will not start before the temperature on T3 sensor reaches the cut-in temperature.

Range: 14...37°C / 57...99°F

Default: 36°C / 96°F

---

### **P44 – Soft start in heat – cut-out temperature**

The fan will stop if the temperature on T3 sensor drops below the cut-out temperature.

Range: 14...37°C / 54...95°F

Default: 32°C / 89°F

---

### **P45 – Cool differential band (On/Off)**

Range: 0...5°C / 0...10°F

Default: 1°C / 2°F

---

### **P46 – Cool differential band offset**

Range: 0...5°C / 0...10°F

Default: 0°C / 0°F

---

### **P47 – Heat differential band (On/Off)**

Range: 0...5°C / 0...10°F

Default: 1°C / 2°F

---

### **P48 – Heat differential band offset**

Range: -5...0°C / -10...0°F

Default: 0°C / 0°F

---

## 4. Technician settings (cont')

---

**P49 – Shift between Cool and Heat in Auto change over mode**

Range: 0...10°C / 0...20°F

Default: 2°C / 4°F

---

**P51 – Shift between Heating stages**

Range: 0...10°C / 0...20°F

Default: 2°C / 4°F

---

**P52 – Cool proportional band (FC only!)**

Range: 2...10°C / 4...20°F

Default: 2°C / 4°F

---

**P53 – Cool proportional low limit (FC only!)**

Range: 0...100%

Default: 0%

---

**P54 – Cool proportional high limit (FC only!)**

Range: 0...100%

Default: 100%

---

## 4. Technician settings (cont')

---

**P55 – Heat proportional band (FC only!)**

Range: 2...10°C / 4...20°F

Default: 2°C / 4°F

---

**P56 – Heat proportional low limit (FC only!)**

Range: 0...100%

Default: 0%

---

**P57 – Heat proportional high limit (FC only!)**

Range: 0...100%

Default: 100%

---

**P60 – Proportional ON percent (FC only!)**

Range: 0...30%

Default: 30%

---

**P60 – Proportional OFF percent (FC only!)**

Range: 0...20%

Default: 10%

---

## 4. Technician settings (cont')

---

**P63 – Time on-delay between cooling stages**

Range: 0...600 seconds

Default: 5 seconds

---

**P64 – Time off-delay between cooling stages**

Range: 0...600 seconds

Default: 1 seconds

---

**P65 – Fan VFS proportional band in cooling**

Range: 2...10°C / 4...20°F

Default: 2°C / 4°F

---

**P66 – Fan VFS proportional band in heating**

Range: 2...10°C / 4...20°F

Default: 2°C / 4°F

---

**P67 – Fan VFS Low speed percent in cooling**

Range: 0...30%

Default: 20%

---

**P68 – Fan VFS Medium speed percent in cooling**

Range: 30...60%

Default: 50%

---

**P69 – Fan VFS High speed percent in cooling**

Range: 60...100%

Default: 90%

---

## 4. Technician settings (cont')

---

**P70 – Fan VFS Low speed percent in heating**

Range: 0...30%

Default: 30%

---

**P71 – Fan VFS Medium speed percent in heating**

Range: 30...60%

Default: 50%

---

**P72 – Fan VFS High speed percent in heating**

Range: 60...100%

Default: 80%

---

**P73 – VFS Medium speed differential**

Range: 10...50%

Default: 35

---

**P74 – VFS High speed differential**

Range: 10...50%

Default: 35

---

## 4. Technician settings (cont')

---

**P76 – Fan VFS Low limit in cooling**

Range: 0...100%

Default: 0%

---

**P77 – Fan VFS High limit in cooling**

Range: 0...100%

Default: 100%

---

**P78 – Fan VFS Low limit in heating**

Range: 0...100%

Default: 0%

---

**P79 – Fan VFS High limit in heating**

Range: 0...100%

Default: 100%

---

**P83 – View T2 temperature sensor readings**

Note: If T2 is not connected, -9.8°C / -9.8°F  
will appear on display

---

**P84 – View T3 temperature sensor readings**

Note: If T3 is not connected, -9.8°C / -9.8°F  
will appear on display

---

## 4. Technician settings (cont')

---

**P85 – Deice in cool – cut-in temperature (AC only!)**

Range: -20...99°C

Default: 0°C

---

**P86 – Deice in cool – cut-out temperature (AC only!)**

Range: -20...99°C

Default: 8°C

---

**P87 – Deice in heat time (AC only!)**

Range: 120...420 Seconds

Default: 300 Seconds

---

**P88 – Deice in heat break time (AC only!)**

Range: 600...1800 Seconds

Default: 1500 Seconds

---

**P89 – Deice in heat – cut-in temperature (AC only!)**

Range: -20...99°C

Default: 0°C

---

**P90 – Deice in heat – cut-out temperature (AC only!)**

Range: -20...99°C

Default: 16°C

---

**P91 – Compressor delay (AC only!)**

Range: 0...360 Seconds

Default: 10 Seconds

---

## 4. Technician settings (cont')

---

### **P99 – One or Two set points (for cool and for heat)**

“00” - One set point for cooling and heating (default)

“01” - two set points – one for cool and one for heat

---

### **P100 – Enable/Disable Screen dimming**

“00” - Enable

“01” - Disable (default)

---

### **P101 – Screen dimming delay**

Range: 0...99 minutes

Default: 5 minutes

---

### **P102 – Dimming percentage value**

Range: 1,5,10...90%

Default: 10%

---

### **P105 – Display brightness**

Range: 50...100%

Default: 100%

---

### **P114 – Cool PID Kp (FC only!)**

Range: 0...100%

Default: 100%

---

### **P115 – Heat PID Kp (FC only!)**

Range: 0...100%

Default: 100%

---



## 4. Technician settings (cont')

---

### **P116 – Cool PID Ki (FC only!)**

Range: 0...100%

Default: 0%

---

### **P117 – Heat PID Ki (FC only!)**

Range: 0...100%

Default: 0%

---

### **P118 – Cool PID Kd (FC only!)**

Range: 0...100%

Default: 1%

---

### **P119 – Heat PID Kd (FC only!)**

Range: 0...100%

Default: 1%

---

### **P200 – Restore defaults**

Press the  button to restore defaults

Press the  button twice to return to normal display





---

**Press the  button to return to parameter P1 or wait 60 seconds to exit technician settings and return to normal display.**

## 5. MAC Address

---

### Enter MAC Address settings

- Adjust the set-point temperature to 11°C – the button  will appear on display.
- To enter MAC Address settings, press and hold the  button for 5 seconds.
- Use the  and  buttons to change the MAC Address.  
Set “0” for no communication.
- Press the  button to return to normal display.

## Comments

---

A series of 20 horizontal dashed lines for writing comments.

